

VERTICAL INLINE CENTRIFUGAL PUMP

FIC / FIS SERIES - 50 Hz

Zirantec



www.zirantec.com



FABBRICA ITALIANA POMPE SOMMERSIBILI S.r.l



ZIRANTEC products are manufactured by well qualified and experienced Italian Pump Engineers in state of the art manufacturing facilities in Italy

CERTIFICATION

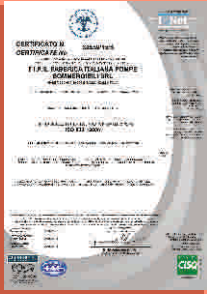

ZIRANTEC Pumps & Motors are from the house of **Fabbrica Italiana Pompe Sommergibili S.r.l.** a four decades old Italian company of high repute, offering complete waste water solutions around the world. Its current product portfolio includes world class Waste Water Pumps of various types, Multistage Centrifugal Pressure Booster Pumps, Borehole Submersible Pumps & Motors, End Suction Centrifugal Pumps, Industrial Pumps for various applications.

Founded as early as 1978 in Rozzano, South of Milan, Italy by Mr.Orfeo Agostini, the company has witnessed steady growth and market expansion continuously ever since. In these four decades of existence, the company has carved a niche for itself in the waste water and sewage pump market in Italy and other countries. Its products are employed in Municipal, Domestic and Industrial applications. The Company is well known for the unique and robust designs of its products and their workmanship. Due to its superior quality ZIRANTEC products are also exported to many European, African and Asian countries.

ZIRANTEC's products are conceived, designed and manufactured by well qualified and experienced Italian Pump Engineers in state of the art manufacturing facilities in Italy. These manufacturing plants are accredited with UNI EN ISO 9001:2008 Certification.

Over the years, the company has metamorphosed and ventured into manufacturing of high quality water pumps, for domestic, agricultural and industrial applications. In the due process, Fabbrica Italiana Pompe Sommergibili S.r.l. has shed its image of an exclusive sewage and waste water pumps manufacturer to a complete pump production company with an ability to manufacture diverse kinds of pumps for different applications.

C O N T E N T S

HORIZONTAL MULTI-STAGE CENTRIFUGAL PUMPS

FHMW SERIES	PageNo.
CONSTRUCTION, FEATURES	5
APPLICATION, OPERATION LIMITS & MOC	6
CROSS SECTIONAL DRAWING	7 - 9
PERFORMANCE CURVES & TABLES	10 - 39
OVERALL DIMENSION DRAWING	40
OVERALL DIMENSIONS	41 - 47
OVERALL DIMENSION DRAWING - HIGH PRESSURE	48
OVERALL DIMENSIONS - HIGH PRESSURE	49
INLET AND OUTLET FLANGES DIMENSION	50 - 51

MODEL IDENTIFICATION CODE

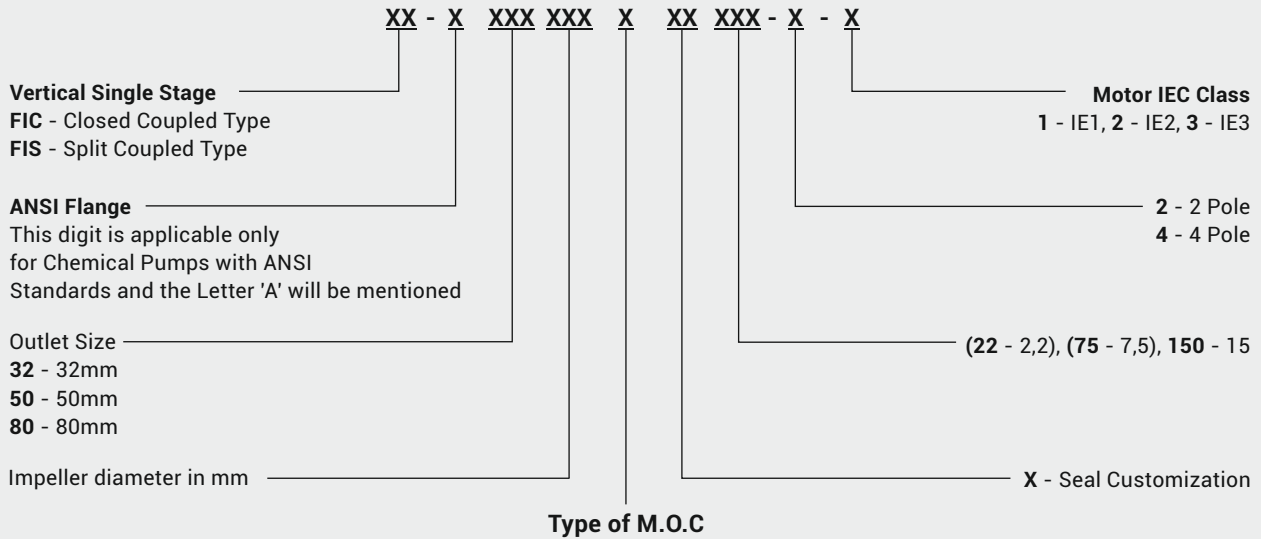

Type	Volute Casing	Impeller	Shaft	Wear ring
C	C.I	C.I	SS (410)	C.I
B	C.I	Br	SS (410)	Br

TECHNICAL SPECIFICATIONS

Power range	: upto 90kW - FIC Series / upto 75kW - FIS Series
Flow rate	: upto 503 m ³ /h - FIC Series / upto 421 m ³ /h - FIS Series
Head range	: upto 96 m
Max. Liquid Temperature	: up to 130°C
Max. Operating Pressure	: up to 16 bar
Speed	: 1450/2900 rpm - FIC Series / 1450 rpm - FIS Series
Voltage	: 380/415V, 50 Hz
Duty type	: S1
Efficiency class	: IE1 (Optional - IE2/IE3)
Internal Protection	: IP 55
Insulation class	: F
Shaft seal	: Mechanical seal
Impeller type	: Enclosed
Liquid handled	: Liquid not chemically or mechanically aggressive to the pump parts
Direction of rotation	: Clockwise when viewed from DE(CW)
Inlet & outlet size ranges	: 40mm to 200mm
Flange standard	: DIN 2533 / PN 16 with optional ANSI 150

GENERAL INSTRUCTIONS

- Performance curves are as per specific gravity and viscosity of water.
- Curve tolerance according to ISO 9906 : 2012 Table 8 - 2B.
- For Safety consider a margin of 0,5m higher of NPSH.
- All dimensions are in mm
- In view of continuous developments the information / performance / descriptions / specifications / Illustrations mentioned in this catalogues are subject to change without notice.

GENERAL INFORMATION FIC SERIES



ZIRANTEC FIC Series Vertical Inline Pumps are of single stage, non-self-priming, close-coupled pumps with radial suction and radial discharge port. These pumps are designed to meet high pumping requirements in terms of performance, efficiency & reliability which include different sizes of pumps that are customized to suit the specific requirement of the customer. The top pull out design facilitates dismantling of motor, motor bracket and impeller without disturbing the volute casing from the piping system. The inline construction simplifies the piping work and major saving on floor space compared to other type of pumps. These pumps are offered with standard motors only and IE2/IE3 motors also can be supplied on request.



APPLICATIONS

- Heating systems
- Air conditioning systems
- Cooling circuits
- General utility water supply in industries
- Pressure boosting systems
- Fire fighting systems

DESIGN FEATURES

- Dynamic balanced impeller maximise bearing life and vibration free operation
- Impeller can be supplied with optional wear ring
- Pump is suitable for fixed and variable speed
- Pump can be supplied with optional flange dimensions complying to DIN, ISO & ANSI
- Top pull out design
- Inter changeability of spare parts reduces inventory requirement at customer end

GENERAL INFORMATION - FIC SERIES

DUTY POINTS - 1450 rpm

Sl. No.	Pump model	Pump Size	Head (m)	Flow (m ³ /hr)	Speed (rpm)	Motor Power (kW)	Frame Size
1	FIC - 40/160-4	40x40	9	10	1450	0,75	80
2	FIC - 50/160-4	50x50	9	24	1450	1,1	90S
3	FIC - 65/160-4	65x65	7	24	1450	1,5	90L
4	FIC - 80/160-4	80x80	9	50	1450	2,2	100L
5	FIC - 80/200-4	80x80	16	53	1450	5,5	132S
6	FIC - 100/200-4	100x100	15	107	1450	7,5	132M
7	FIC - 125/200-4	125x125	12	158	1450	9,3	160M
8	FIC - 150/200-4	150x150	13	234	1450	15	160L
9	FIC - 40/250-4	40x40	24	23	1450	3	100L
10	FIC - 50/250-4	50x50	20	35	1450	3,7	112M
11	FIC - 65/250-4	65x65	22	49	1450	5,5	132S
12	FIC - 80/250-4	80x80	19	65	1450	7,5	132M
13	FIC - 100/250-4	100x100	15	107	1450	11	160M
14	FIC - 125/250-4	125x125	19	150	1450	15	160L
15	FIC - 150/250-4	150x150	18	253	1450	22	180L
16	FIC - 200/250-4	200x200	17	418	1450	37	225SX
17	FIC - 80/360-4	80x80	36	99	1450	15	160L
18	FIC - 100/380-4	100x100	39	214	1450	45	225SX
19	FIC - 150/380-4	150x150	42	357	1450	55	250MX
20	FIC - 200/380-4	200x200	36	503	1450	75	280SX
21	FIC - 100/400-4	100x100	43	101	1450	30*	200L

DUTY POINTS - 2900 rpm

Sl. No.	Pump model	Pump Size	Head (m)	Flow (m ³ /hr)	Speed (rpm)	Motor Power (kW)	Frame Size
1	FIC - 40/160-2	40x40	35	21	2900	5,5	112M
2	FIC - 50/160-2	50x50	41	37	2900	9,3	132M
3	FIC - 65/160-2	65x65	35	67	2900	15	160M
4	FIC - 80/160-2	80x80	32	107	2900	18,5	160L
5	FIC - 80/200-2	80x80	63	113	2900	30	200L
6	FIC - 40/250-2	40x40	94	24	2900	22	180M
7	FIC - 50/250-2	50x50	89	47	2900	30	200L
8	FIC - 65/250-2	65x65	86	75	2900	37	200L
9	FIC - 100/200-2	100x100	60	171	2900	45	225M
10	FIC - 125/200-2	125x125	50*	281*	2900	75*	280S
11	FIC - 150/200-2	150x150	41*	421*	2900	90*	280M

* On request

GROUP PERFORMANCE CURVE - FIC SERIES

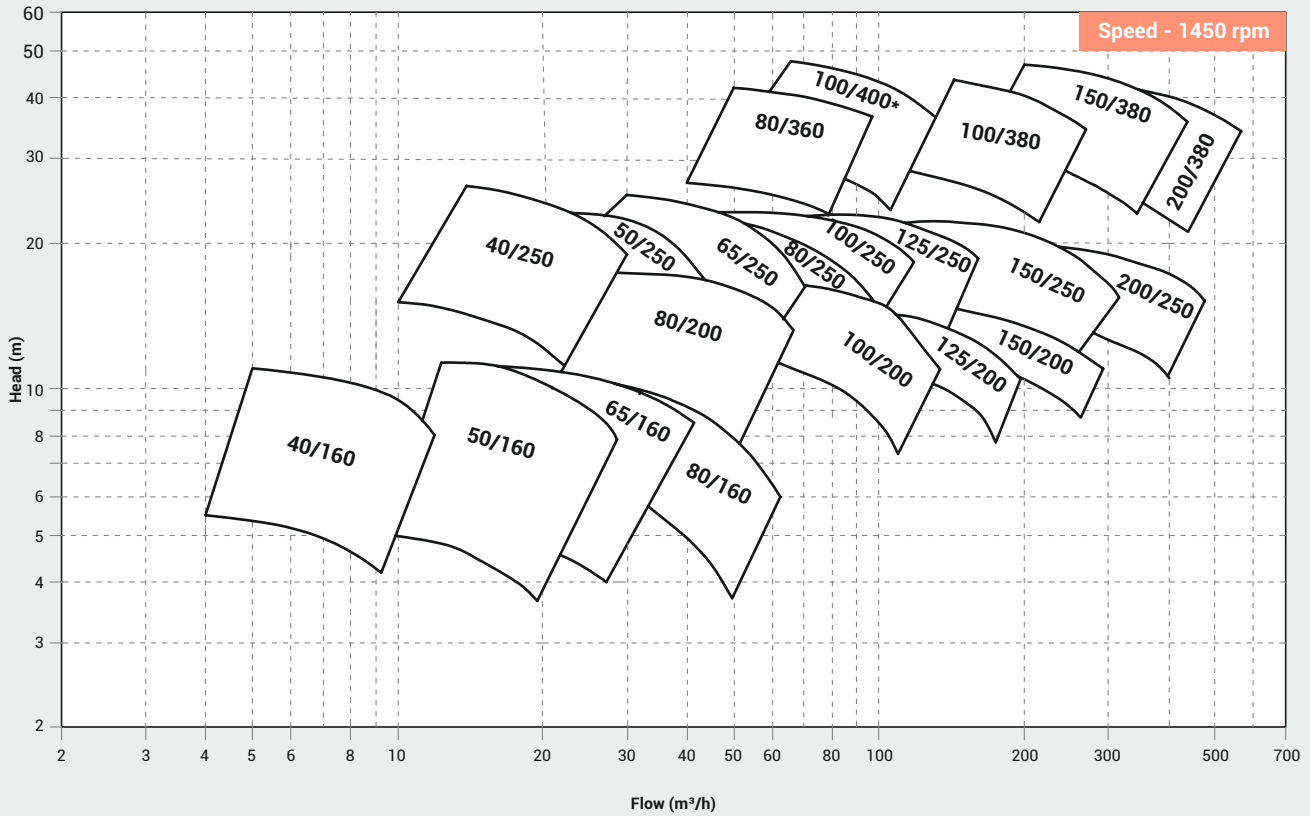

GROUP PERFORMANCE CURVE - FIC SERIES

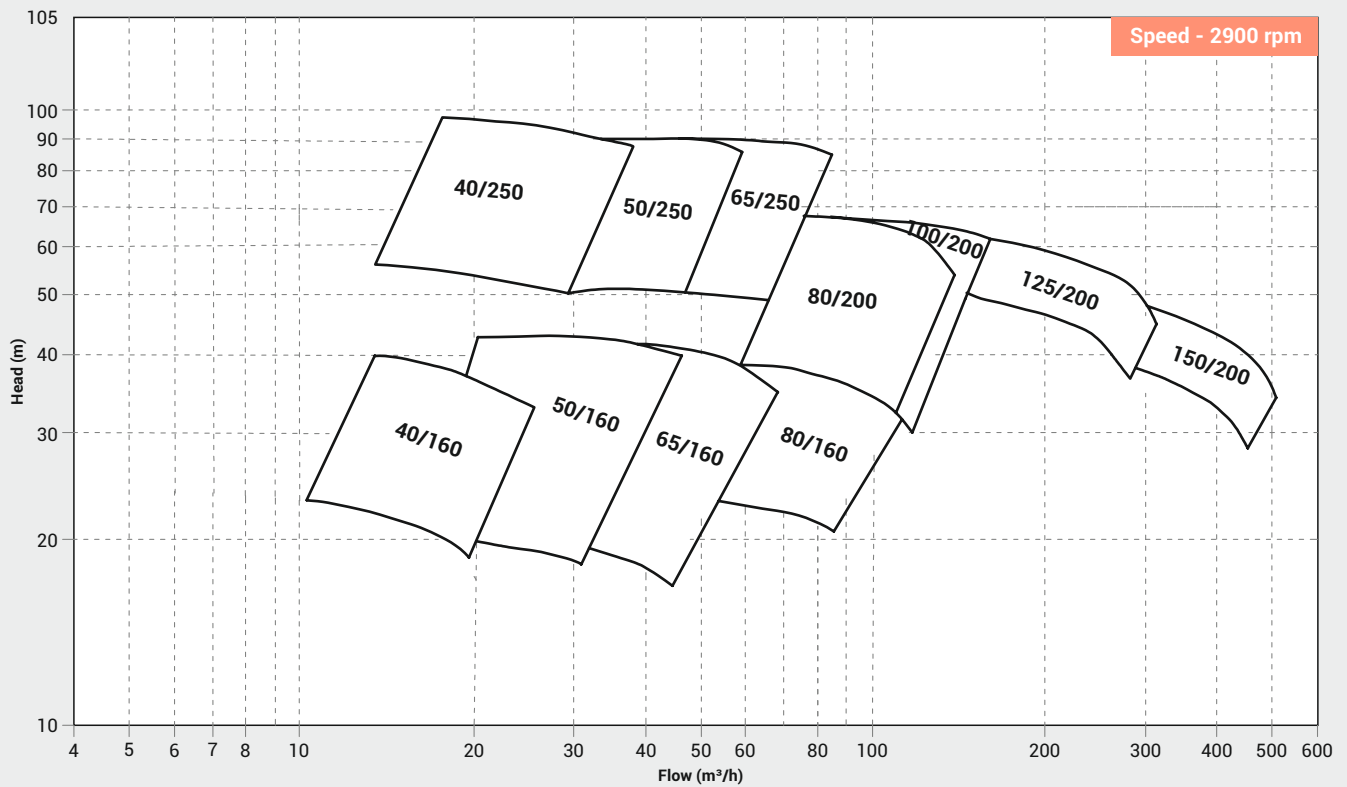

CROSS SECTIONAL DRAWING - FIC SERIES

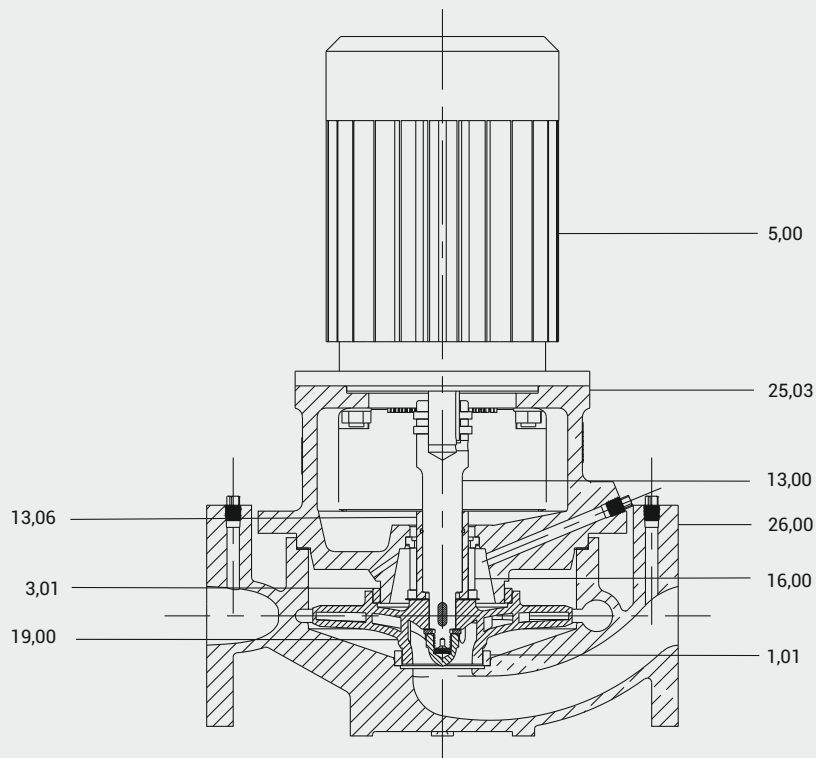

Part No	Part Name
26,00	Casing
19,00	Impeller
1,01	Front wear ring
3,01	Rear wear ring
25,03	Motor bracket
13,00	Shaft
5,00	Motor
16,00	Mechanical seal
13,06	Shaft sleeve

INTERCHANGEABILITY CHART - FIC SERIES

Model Part Name	Casing	Impeller	Shaft	Sleeve Shaft	Motor Bracket	Stuffing Box	Front Wear Ring	Rear Wear Ring	Mechanical Seal				
FIC - 40/160-4	1	1	1	1	1	NA	1	1	1				
FIC - 50/160-4	2	2	2										
FIC - 65/160-4	3	3	2										
FIC - 80/160-4	4	4	3	4	2		3	2	2				
FIC - 80/200-4	7	7	4		3		4		3				
FIC - 100/200-4	8	8	2		4		5•		4				
FIC - 125/200-4	9	9	5	2	4		6	2	4				
FIC - 150/200-4	10	10					1			2	7	2	
FIC - 40/250-4	11	11					1			2	8	1	2
FIC - 50/250-4	12	12	4	2	5		9	2	3				
FIC - 65/250-4	13	13					10						
FIC - 80/250-4	14	14					11			2	4		
FIC - 100/250-4	15	15	5	2	6		12	2	4				
FIC - 125/250-4	16	16	6				13						
FIC - 150/250-4	17	17	7				3			7	14	3	5
FIC - 200/250-4	18	18	7	3	7	14	3	5					
FIC - 80/360-4	19	19	5	2	8	1	15	5•	6				
FIC - 100/380-4	20	20	8	3	9	2	16	4	7				
FIC - 150/380-4	21	21	7				17		5				
FIC - 200/380-4	22	22	9				18		7				
FIC - 100/400-4	23	23	8	1	2	3	19	1	7				
FIC - 40/160-2	1	1	10				1		10	NA	1	1	1
FIC - 50/160-2	2	2	11										
FIC - 65/160-2	3	3	12	11	2	1		1					
FIC - 80/160-2	4	4	13	2	12	3	2	2					
FIC - 80/200-2	7	7	14			7		1	3				
FIC - 40/250-2	11	11	15			1		10	8		1	3	
FIC - 50/250-2	12	12	17	14	4	9	9	2	4				
FIC - 65/250-2	13	13	2				12				4	2	
FIC - 100/200-2	8	8	15				12				5•	4	2
FIC - 125/200-2	9	9	15	2	12	6	2	4					
FIC - 150/200-2	10	10											

1
1 In each part, same number means same component

5•
5• Same symbol and number in different parts means same component

DIMENSIONAL DETAILS - FIC SERIES

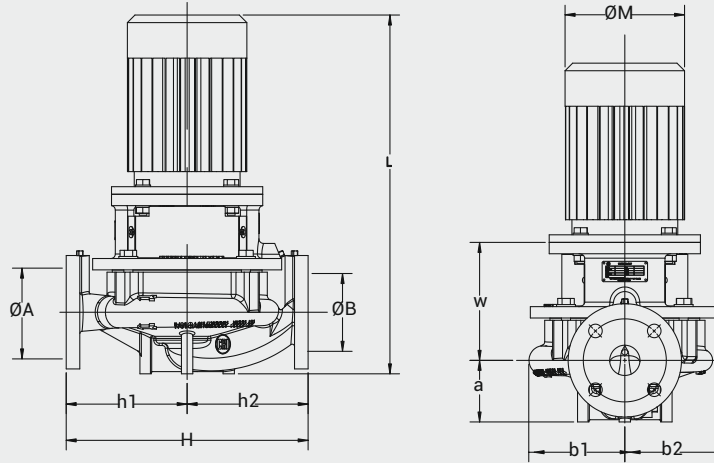

PUMP MODEL	PUMP SIZE	ØA	ØB	H	h1	h2	a	w	b1	b2	L	ØM	Weight kg (with motor)	Frame Size
FIC - 40/160-4	40x40	40	40	320	160	160	81,5	156	127	125	479,5	158	40	80
FIC - 50/160-4	50x50	50	50	340	170	170	90	162	130	125	521	180	47	90S
FIC - 65/160-4	65x65	65	65	350	180	170	100	164	125	145	558	180	53	90L
FIC - 80/160-4	80x80	80	80	400	200	200	108	162	125	159	584	198	64	100L
FIC - 80/200-4	80x80	80	80	500	250	250	122	222	150	166	717	262	113	132S
FIC - 100/200-4	100x100	100	100	550	305	245	143	218	161	188	770	262	127	132M
FIC - 125/200-4	125x125	125	125	620	340	280	175	227	169	206	881	314	177	160M
FIC - 150/200-4	150x150	150	150	690	375	315	184	233	191	243	940	314	208	160L
FIC - 40/250-4	40x40	40	40	440	220	220	83	164	180	180	561	198	78	100L
FIC - 50/250-4	50x50	50	50	440	220	220	93	166	180	180	597	222	92	112M
FIC - 65/250-4	65x65	65	65	500	250	250	113	218	180	184	704	262	122	132S
FIC - 80/250-4	80x80	80	80	520	270	250	113	217	180	190	739	262	131	132M
FIC - 100/250-4	100x100	100	100	550	290	260	132	227	185	210	838	314	214	160M
FIC - 125/250-4	125x125	125	125	610	290	320	154	223	221	191	900	314	208	160L
FIC - 150/250-4	150x150	150	150	700	330	370	195	235	264	215	1013	354	289	180L
FIC - 200/250-4	200x200	200	200	850	450	400	231	279	252	320	1249	435	512	225SX
FIC - 80/360-4	80x80	80	80	655	325	330	150	229	252	231	902	314	203	160L
FIC - 100/380-4	100x100	100	100	710	350	360	178	252	237	267	1081	395	446	225SX
FIC - 150/380-4	150x150	150	150	795	375	420	216	267	285	243	1223	435	545	250MX
FIC - 200/380-4	200x200	200	200	850	400	450	245	291	322	253	1326	481	600	280SX
FIC - 100/400-4	100x100	100	100	725	355	370	175	284	276	253	1109	395	375	200L

PUMP MODEL	PUMP SIZE	ØA	ØB	H	h1	h2	a	w	b1	b2	L	ØM	Weight kg (with motor)	Frame Size
FIC - 40/160-2	40x40	40	40	320	160	160	81,5	156	127	125	576	222	67	112M
FIC - 50/160-2	50x50	50	50	340	170	170	90	212	150	150	711	262	100	132M
FIC - 65/160-2	65x65	65	65	350	180	170	100	214	175	175	793	354	143	160M
FIC - 80/160-2	80x80	80	80	400	200	200	108	212	175	175	878	359	163	160L
FIC - 80/200-2	80x80	80	80	500	250	250	122	242	200	200	1014	416	292	200L
FIC - 40/250-2	40x40	40	40	440	220	220	83	214	180	180	842	354	211	180M
FIC - 50/250-2	50x50	50	50	440	220	220	93	237	200	200	980	395	300	200L
FIC - 65/250-2	65x65	65	65	500	250	250	113	237	200	200	1001	395	318	200L
FIC - 100/200-2	100x100	100	100	550	245	305	143	240	225	225	1123	436	450	225M
FIC - 125/200-2	125x125	125	125	620	287,5	332,5	175	273	275	275	1348	543	677	280S
FIC - 150/200-2	150x150	150	150	690	315	375	183	280	275	275	1363	543	711	280M

GENERAL INFORMATION - FIS SERIES



ZIRANTEC FIS Series Vertical Inline Pumps are of single stage, non-self-priming, split-coupled pumps with radial suction and radial discharge port. These pumps are designed to meet high pumping requirements in terms of performance, efficiency & reliability which include different sizes of pumps that are customized to suit the specific requirement of the customer. The top pull out design facilitates dismantling of motor, motor bracket and impeller without disturbing the volute casing from the piping system. The inline construction simplifies the piping work and major saving on floor space compared to other type of pumps. These pumps are offered with standard motors only and IE2/IE3 motors also can be supplied on request.

APPLICATIONS

- Heating systems
- Air conditioning systems
- Cooling circuits
- General utility water supply in industries
- Pressure boosting systems
- Fire fighting systems

DESIGN FEATURES

- Pump is designed to suit with IEC range of motors
- Weightless balanced aluminium die cast split coupling for vibration free operation
- Keyed split coupling for effective torque transmission
- The lower stuffing box is provided with bronze bush for lateral stability of the shaft.
- A gap of 3mm is provided between lower and upper half of split coupling to ensure proper tightness
- All pumps are fitted with dry type mechanical seal which can withstand temperature upto 150°C. thus eliminate the need of external cooling/flushing
- Dynamic balanced impeller maximize bearing life and vibration free operation
- Impeller can be supplied with optional wear ring
- Pump is suitable for fixed and variable speed
- Pump can be supplied with optional flange dimensions complying to DIN, ISO & ANSI
- Top pull out design
- Inter changeability of spare parts reduces inventory requirement at customer end

GENERAL INFORMATION - FIS SERIES

DUTY POINTS

Sl. No.	Pump model	Pump Size	Head (m)	Flow (m ³ /hr)	Speed (rpm)	Motor Power (kW)	Frame Size
1	FIS - 40/160-4	40x40	10	10	1450	0,75	80
2	FIS - 50/160-4	50x50	9	24	1450	1,1	90S
3	FIS - 65/160-4	65x65	7	24	1450	1,5	90L
4	FIS - 80/160-4	80x80	9	50	1450	2,2	100L
5	FIS - 80/200-4	80x80	16	53	1450	5,5	132S
6	FIS - 100/200-4	100x100	15	107	1450	7,5	132M
7	FIS - 125/200-4	125x125	12	158	1450	9,3	160M
8	FIS - 150/200-4	150x150	13	234	1450	15	160L
9	FIS - 40/250-4	40x40	24	23	1450	3	100L
10	FIS - 50/250-4	50x50	20	35	1450	3,7	112M
11	FIS - 65/250-4	65x65	22	49	1450	5,5	132S
12	FIS - 80/250-4	80x80	19	65	1450	7,5	132M
13	FIS - 100/250-4	100x100	15	107	1450	11	160M
14	FIS - 125/250-4	125x125	19	150	1450	15	160L
15	FIS - 150/250-4	150x150	18	253	1450	22	180L
16	FIS - 200/250-4	200x200	17	418	1450	37	225SX
17	FIS - 80/360-4	80x80	36	99	1450	15	160L
18	FIS - 100/380-4	100x100	39	214	1450	45	225SX
19	FIS - 150/380-4	150x150	42	357	1450	55	250MX
20	FIS - 200/380-4	200x200	36	503	1450	55	280SX
21	FIS - 100/400-4	100x100	41*	101*	1450	30*	200L

* On request

GROUP PERFORMANCE CURVE - FIS SERIES

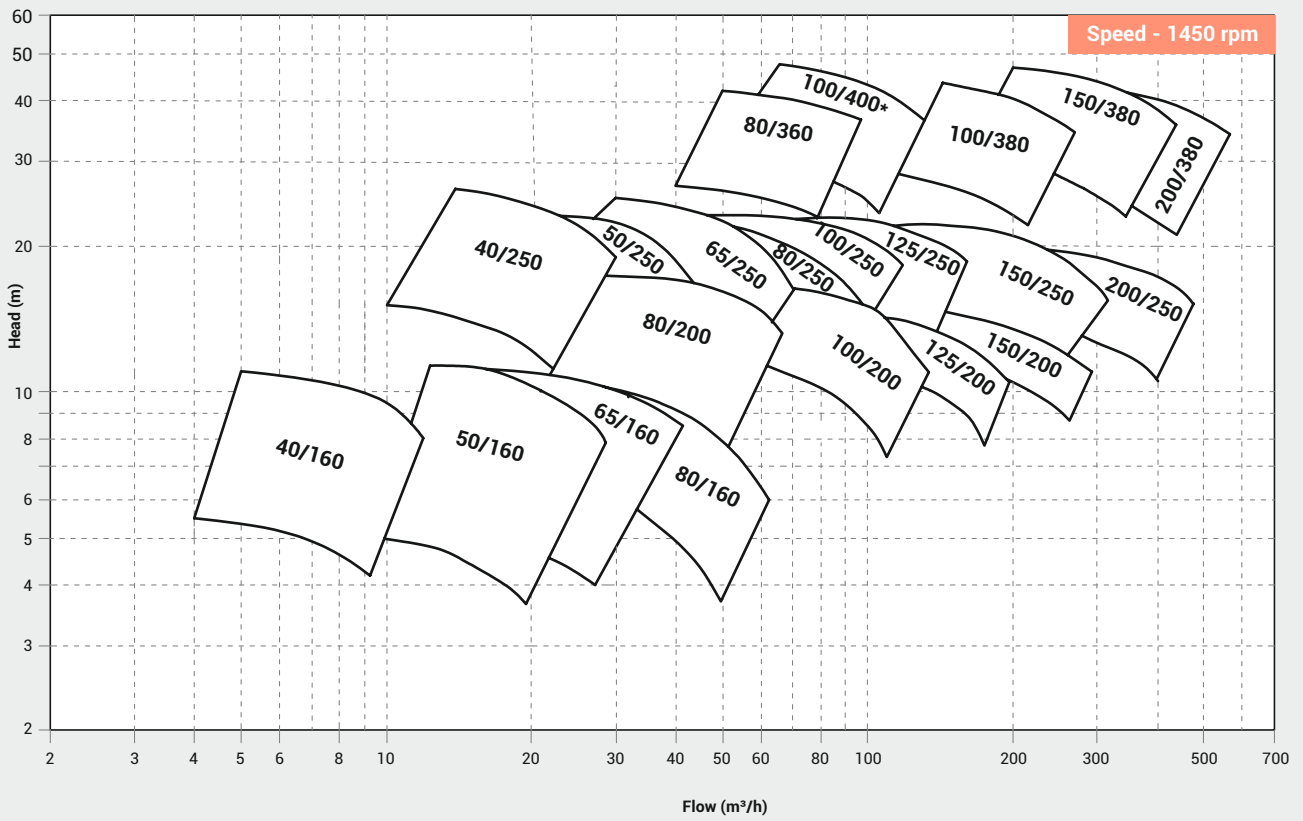

CROSS SECTIONAL DRAWING - FIS SERIES

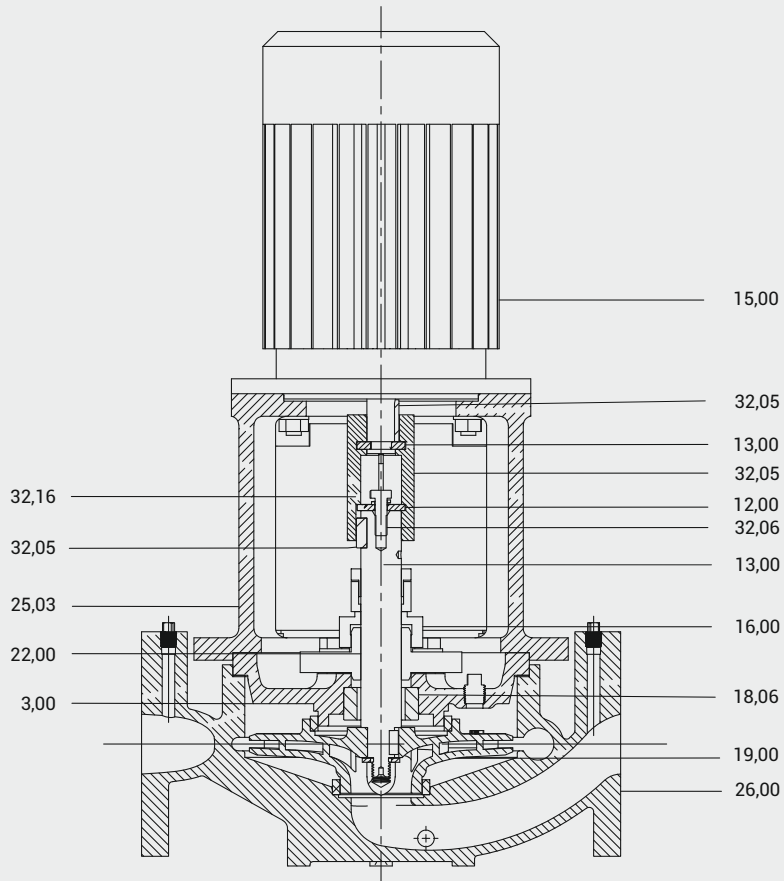

Part No.	Part Name
26,00	Casing
19,00	Impeller
3,00	Stuffing Box
13,00	Pump Shaft
25,03	Motor Bracket
18,06	Throttle Bush
16,00	Mechanical Seal
22,00	Split Coupling
32,05	Key - Pump
32,06	Hex Nut
32,16	Spring Washer
12,00	Coupling Ring
13,00	Split Coupling Washer
32,05	Key - Motor
15,00	Motor

EXPLODED VIEW - FIS SERIES

SPLIT COUPLING

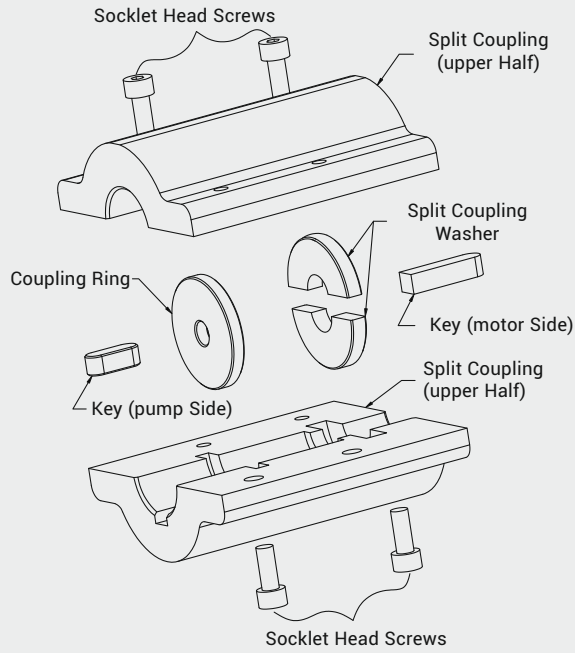

SEALING ARRANGEMENT

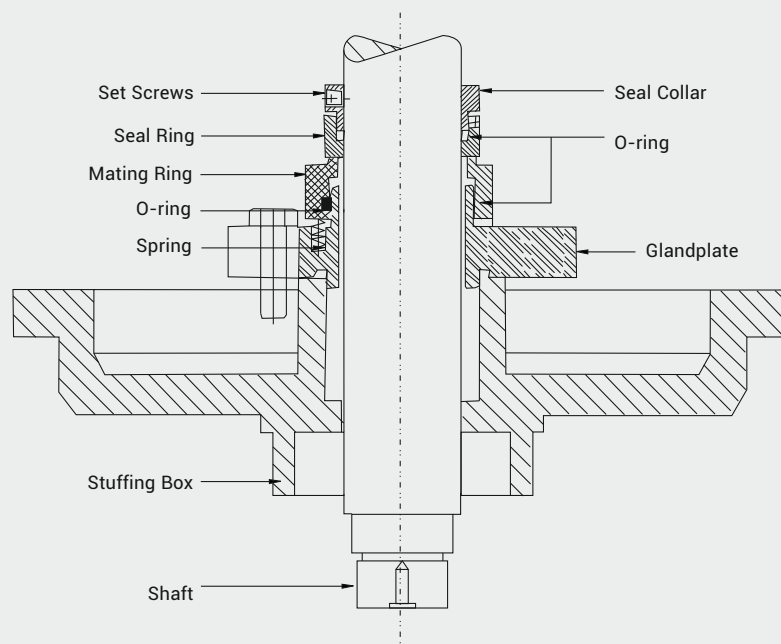

INTERCHANGEABILITY CHART - FIS SERIES

Component / Pump Model	Shaft	Motor Bracket	Coupling Guard	Split Coupling	Coupling Washer	Split Ring	Stuffing Box	Throttle Bush	Mechanical Seal	Casing	Impeller	Front Wearing	Back Wearing	
FIS - 40/160-4	1	1	1	1	1	1	1	1	1	1	1	1	1	
FIS - 50/160-4	2			2		2				2	2	2		
FIS - 65/160-4	3			3		3				3	3	3		
FIS - 80/160-4	3	2	2	3	2	3	2	2	2	4	4	3	2	
FIS - 80/200-4	4	3	3	4						5	5	4		
FIS - 100/200-4	4	3	3	4						6	6	4		
FIS - 125/200-4	5	4	4	5	2	3	2	2	2	7	7	5	2	
FIS - 150/200-4	5	4	4	5						8	8	6		
FIS - 40/250-4	6	2	2	3						1	2	3		3
FIS - 50/250-4	6	2	2	3	1	2	3	3	1	10	10	8		
FIS - 65/250-4	4	5	3	4	2	3	4	2	2	11	11	9	2	
FIS - 80/250-4				4						4	12	12		10
FIS - 100/250-4				5						5	13	13		11
FIS - 125/250-4	5	6	4	5	2	3	4	2	2	14	14	12	2	
FIS - 150/250-4	7	6	4	6						15	15	13		
FIS - 200/250-4	8	7	5	7						3	5	5		4
FIS - 80/360-4	5	8	6	8	2	3	6	2	2	17	17	15	5•	
FIS - 100/380-4	9	9	5	7	3	5	7	4	3	18	18	16	4	
FIS - 150/380-4	8	10		9			8			19	19	17		
FIS - 200/380-4	10	8		9			8			20	20	18		
FIS - 100/400-4	11	11	6	10		6	9	5		21	21	19		

1	In each part, same number means same component
1	

5•	Same symbol and number in different parts means same component
5•	

DIMENSION DRAWINGS - FIS SERIES

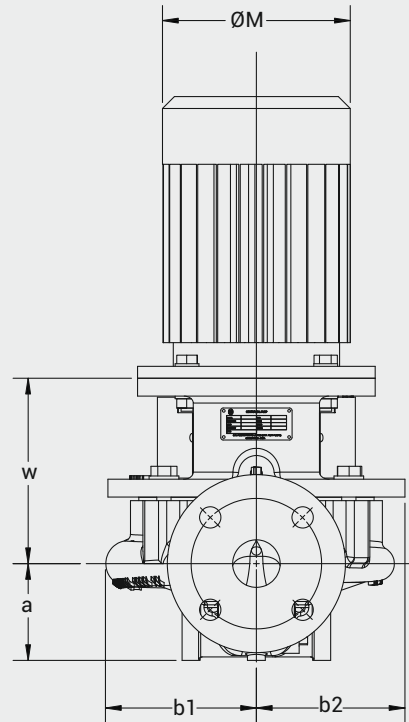
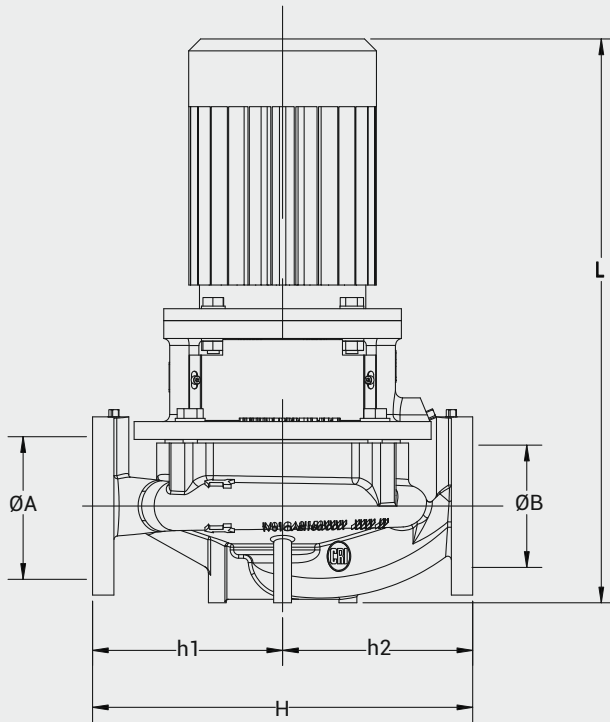

PUMP MODEL	$\varnothing A$	$\varnothing B$	H	h_1	h_2	a	w	b_1	b_2	L	$\varnothing M$	Weight kg (with motor)	Frame Size
FIS - 40/160-4	40	40	320	160	160	81,5	242	127	125	565,5	158	44	80
FIS - 50/160-4	50	50	340	170	170	90	260	130	125	619	180	51	90S
FIS - 65/160-4	65	65	350	180	170	100	261,5	125	145	655,5	180	58	90L
FIS - 80/160-4	80	80	400	200	200	108	268	125	159	690	198	68	100L
FIS - 80/200-4	80	80	500	250	250	122	328,5	150	166	823,5	262	120	132S
FIS - 100/200-4	100	100	550	305	245	143	325	161	188	877	262	134	132M
FIS - 125/200-4	125	125	620	340	280	175	355	169	206	1009	311	184	160M
FIS - 150/200-4	150	150	690	375	315	184	361	191	243	1068	311	216	160L
FIS - 40/250-4	40	40	440	220	220	83	263,5	180	180	660,5	198	83	100L
FIS - 50/250-4	50	50	440	220	220	93	265,5	180	180	696,7	222	96	112M
FIS - 65/250-4	65	65	500	250	250	113	325	180	184	811	262	130	132S
FIS - 80/250-4	80	80	520	270	250	113	318,1	180	190	846	262	140	132M
FIS - 100/250-4	100	100	550	290	260	132	354,5	185	210	965,5	311	190	160M
FIS - 125/250-4	125	125	610	290	320	154	351	221	191	1028	314	215	160L
FIS - 150/250-4	150	150	700	330	370	195	363	264	215	1141	354	295	180L
FIS - 200/250-4	200	200	850	450	400	231	413	252	320	1384	435	530	225SX
FIS - 80/360-4	80	80	655	325	330	150	352	252	231	1025	314	236	160L
FIS - 100/380-4	100	100	710	350	360	178	397	237	267	1315	435	440	225SX
FIS - 150/380-4	150	150	795	375	420	216	410,5	285	243	1416,5	435	565	250MX
FIS - 200/380-4	200	200	850	400	450	245	410,5	322	253	1445,5	481	592	280SX
FIS - 100/400-4	100	100	725	355	370	175	381	276	253	1206	395	400	200L

PERFORMANCE CURVE

Pump Model : FIS - 40/160-4 /
FIC - 40/160-4

Pump Size in mm : 40 x 40

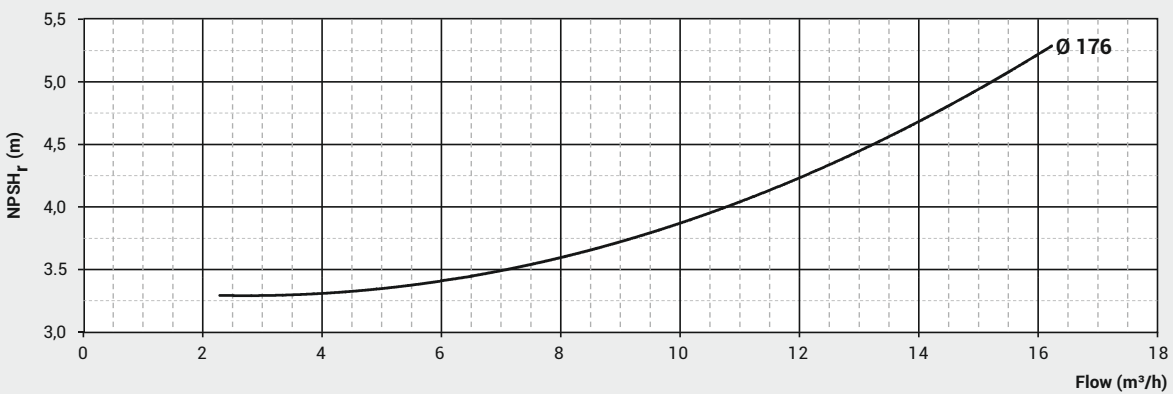
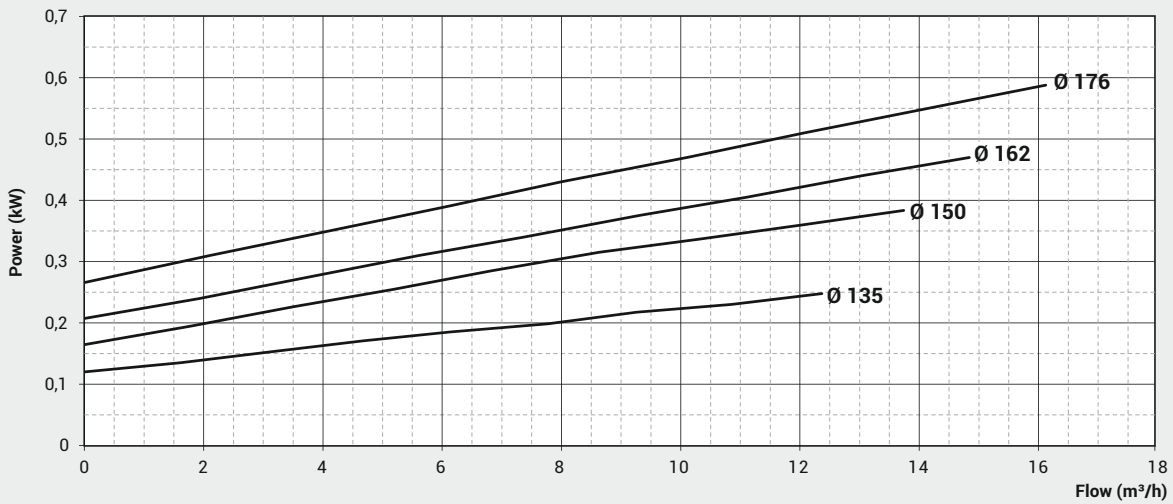
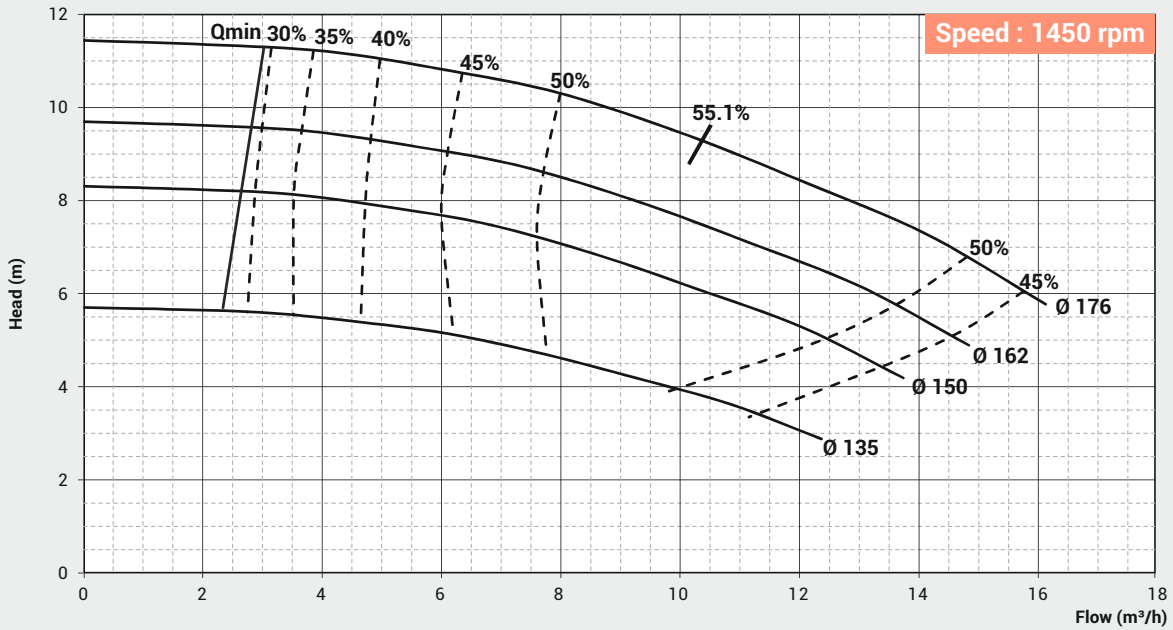

PERFORMANCE CURVE

Pump Model : FIC - 40/160-2

Pump Size in mm : 40 x 40

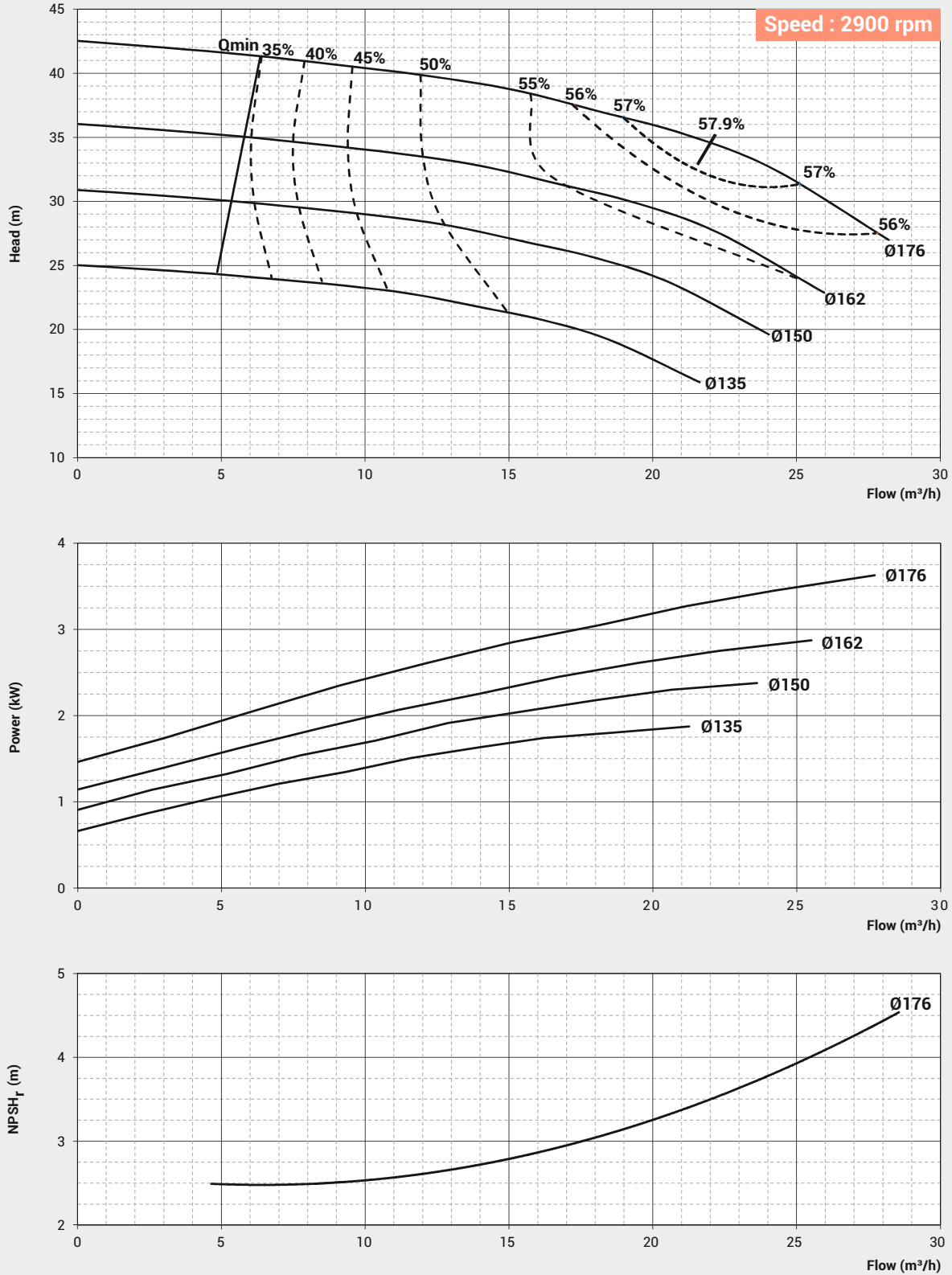

PERFORMANCE CURVE

Pump Model : FIS - 40/250-4 /
FIC - 40/250-4

Pump Size in mm : 40 x 40

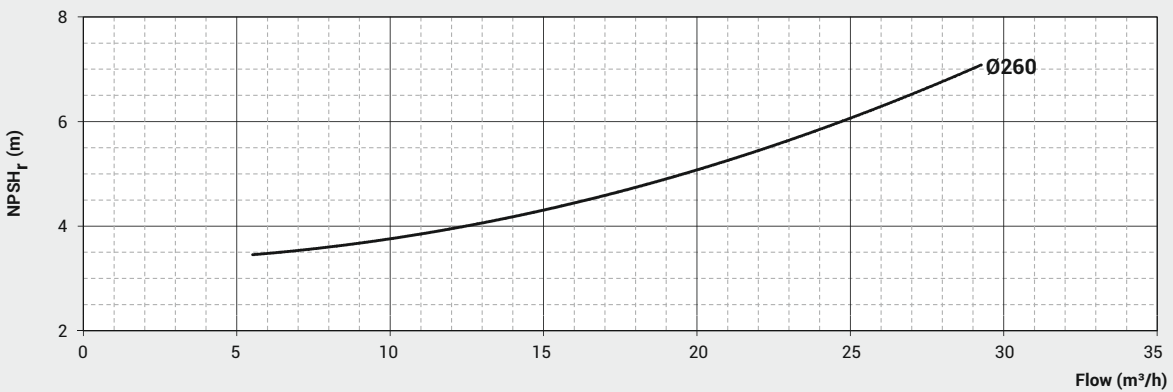
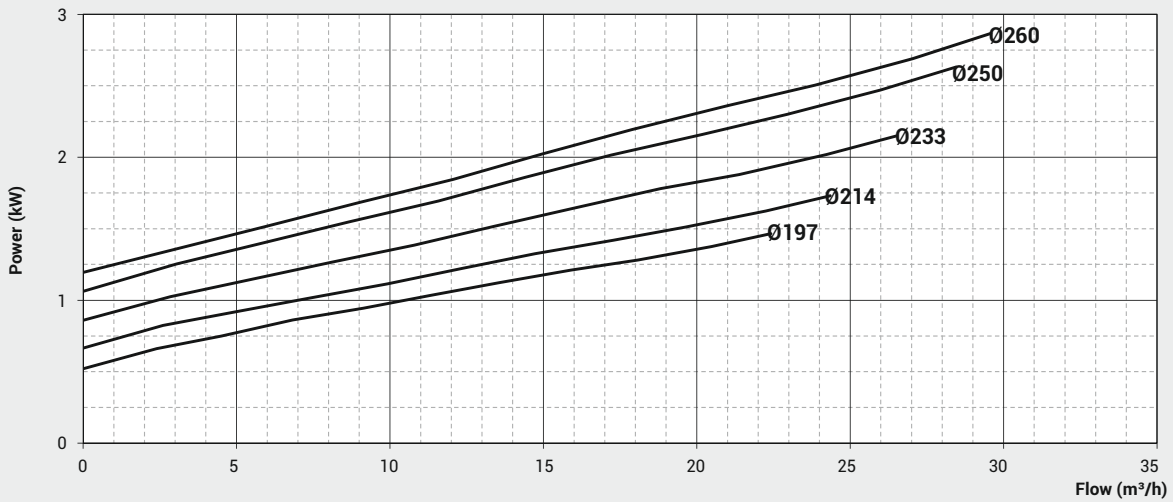
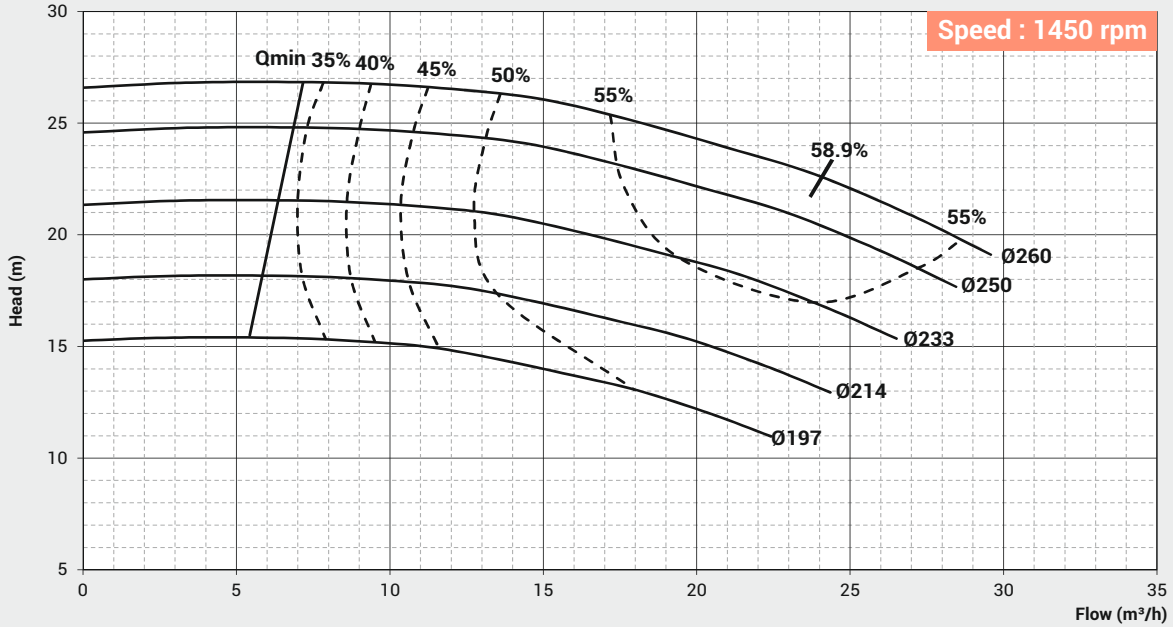

PERFORMANCE CURVE

Pump Model : FIC - 40/250-2

Pump Size in mm : 40 x 40

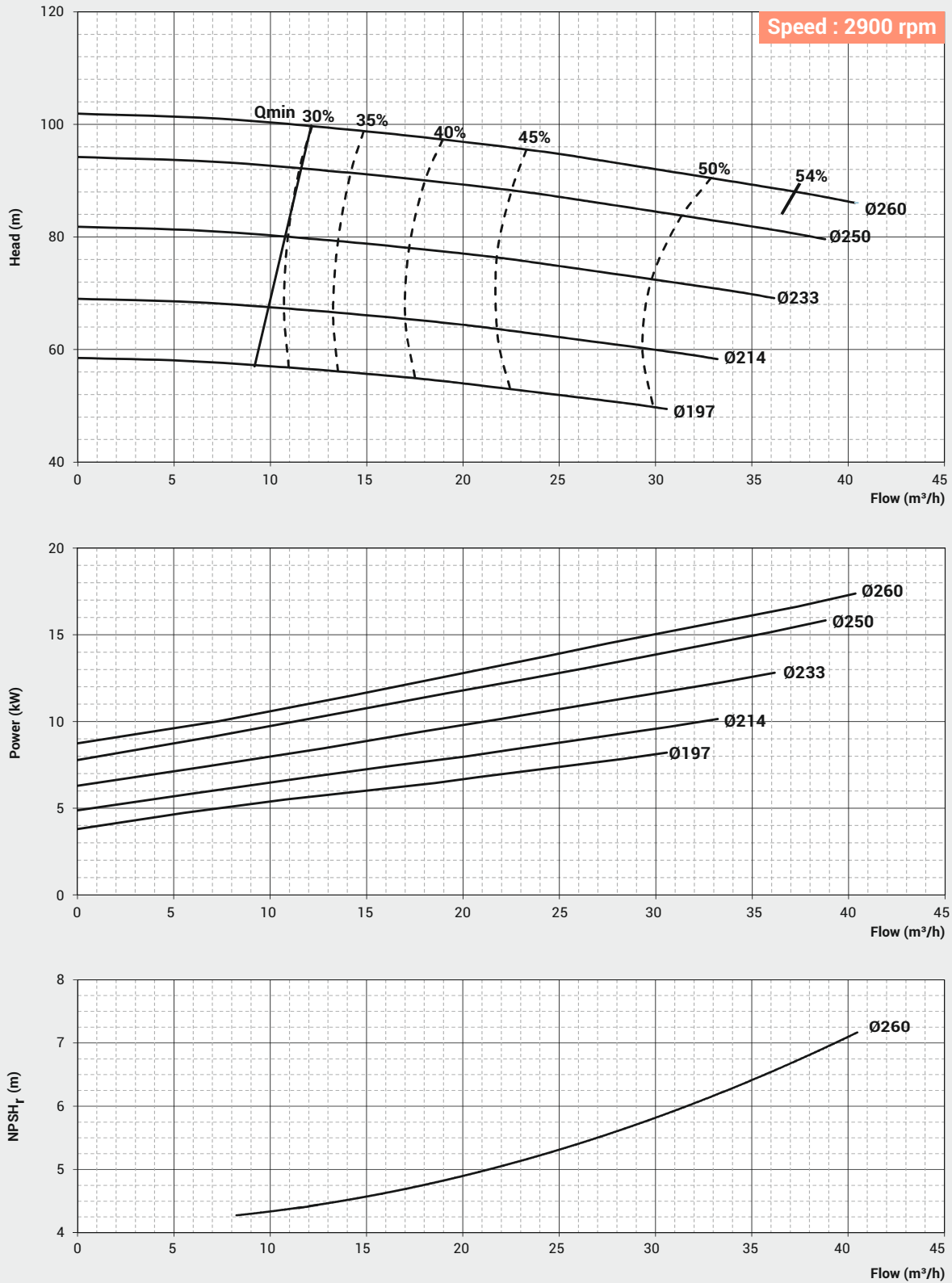

PERFORMANCE CURVE

Pump Model : FIS - 50/160-4 /
FIC - 50/160-4

Pump Size in mm : 50 x 50

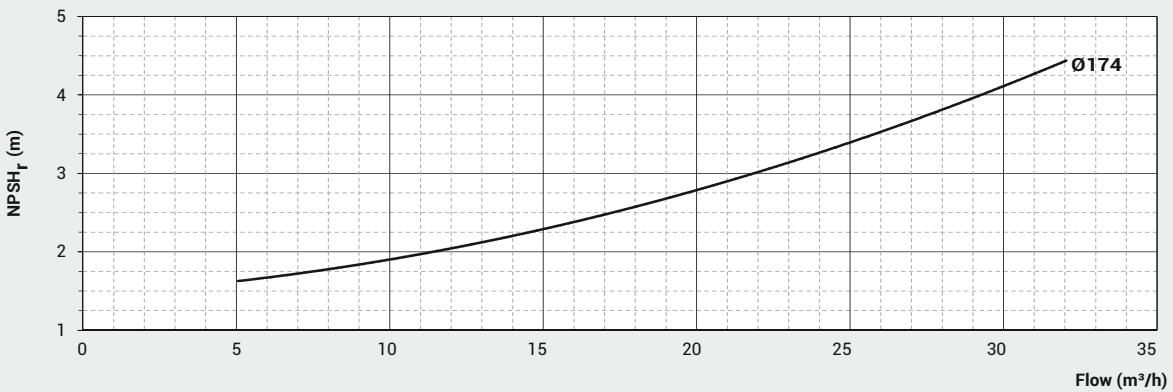
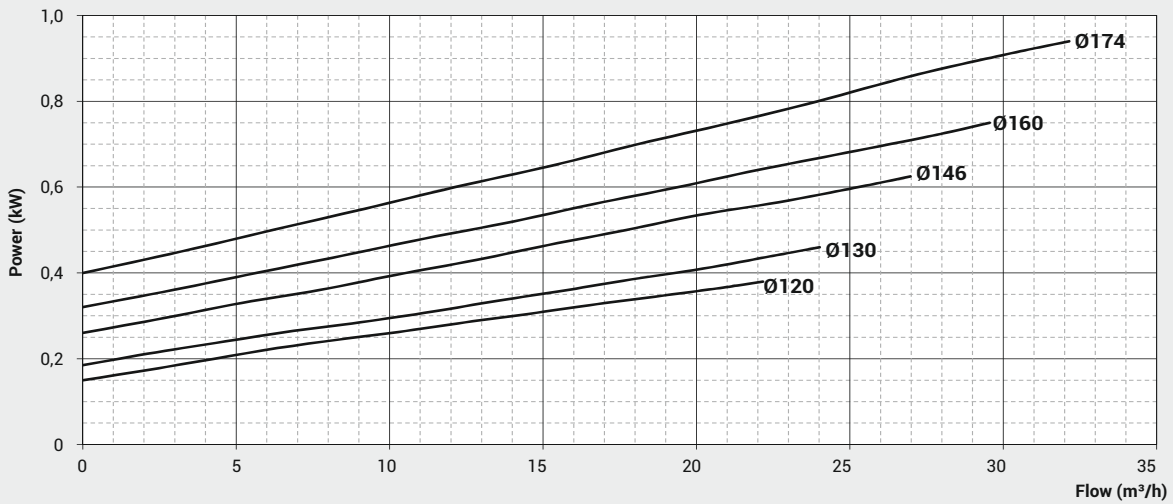
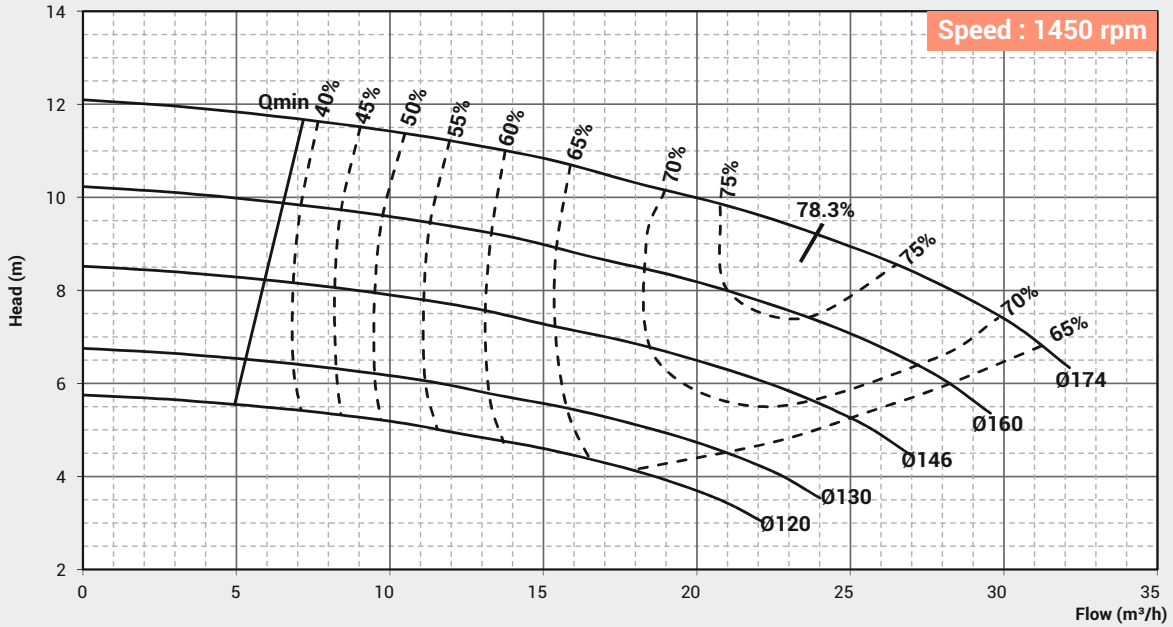

PERFORMANCE CURVE

Pump Model : FIC - 50/160-2

Pump Size in mm : 50 x 50

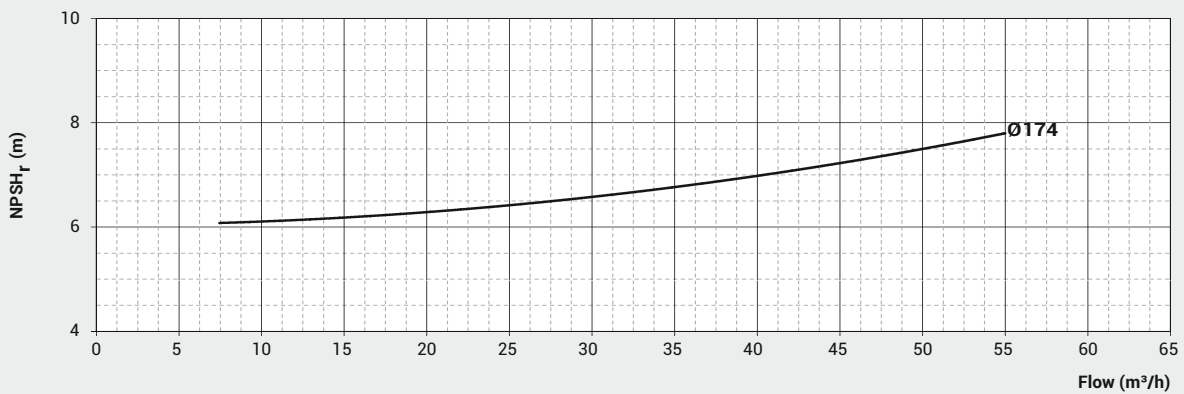
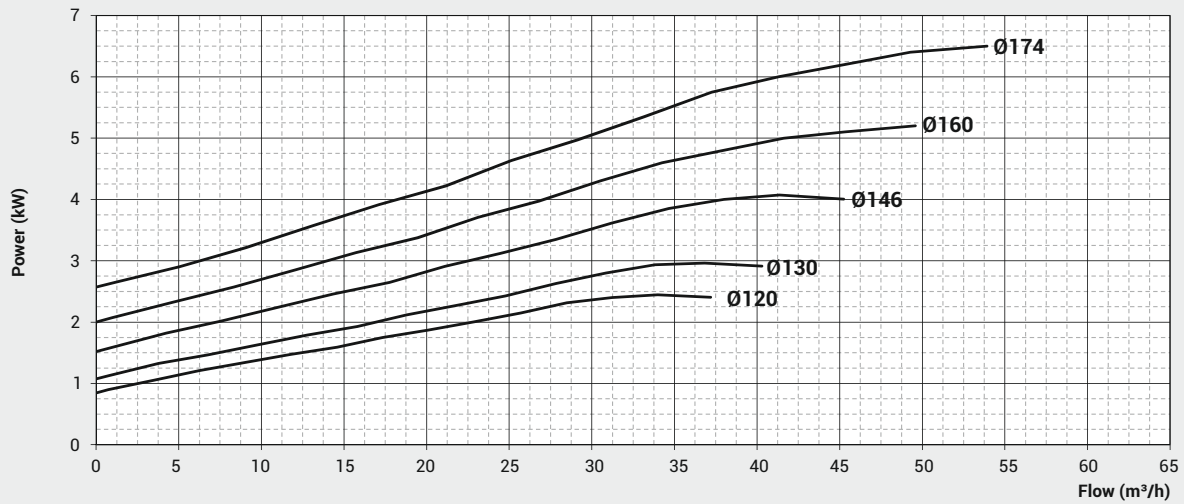
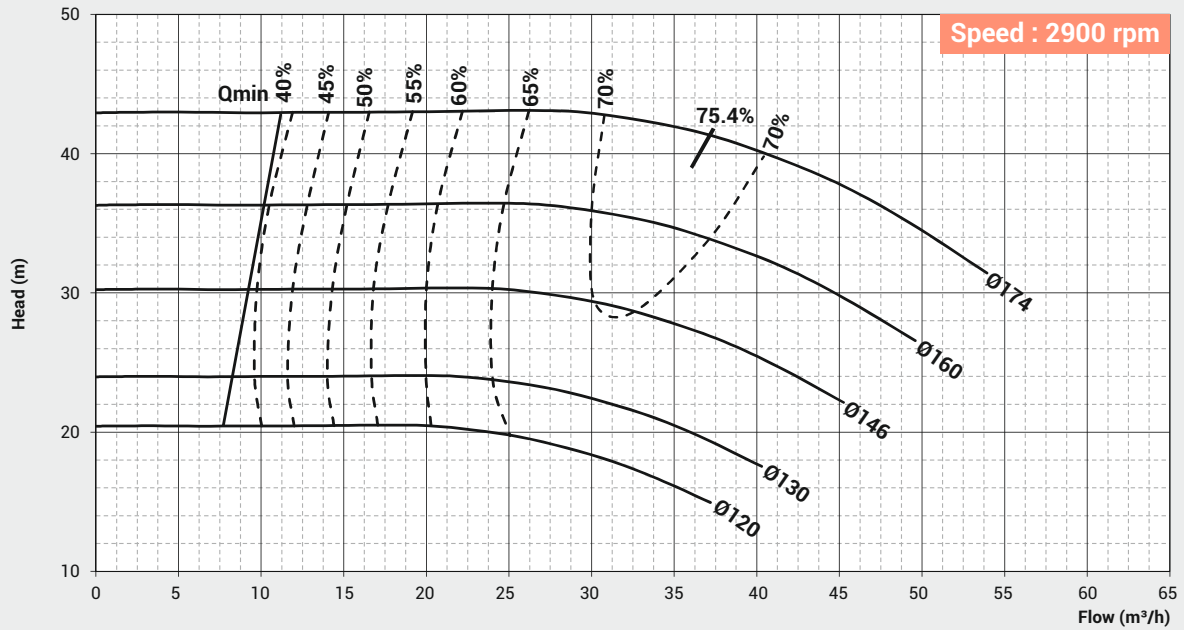

PERFORMANCE CURVE

Pump Model : FIS - 50/250-4 /
FIC - 50/250-4

Pump Size in mm : 50 x 50

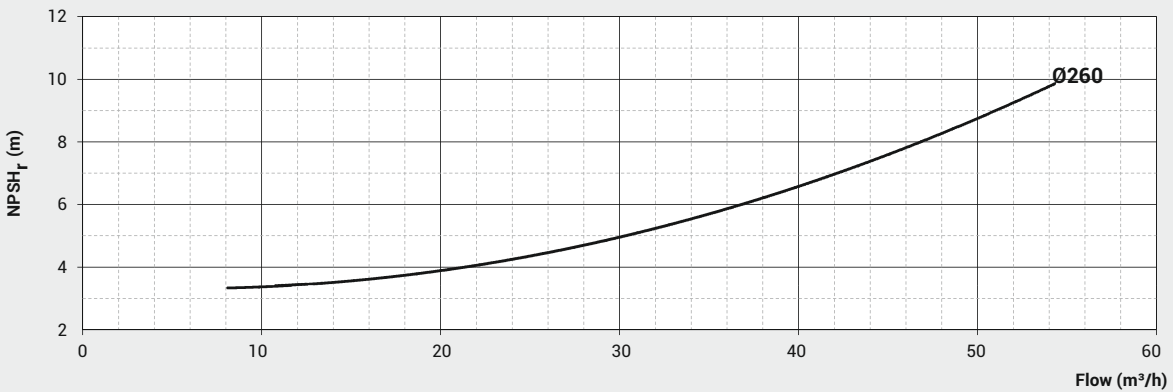
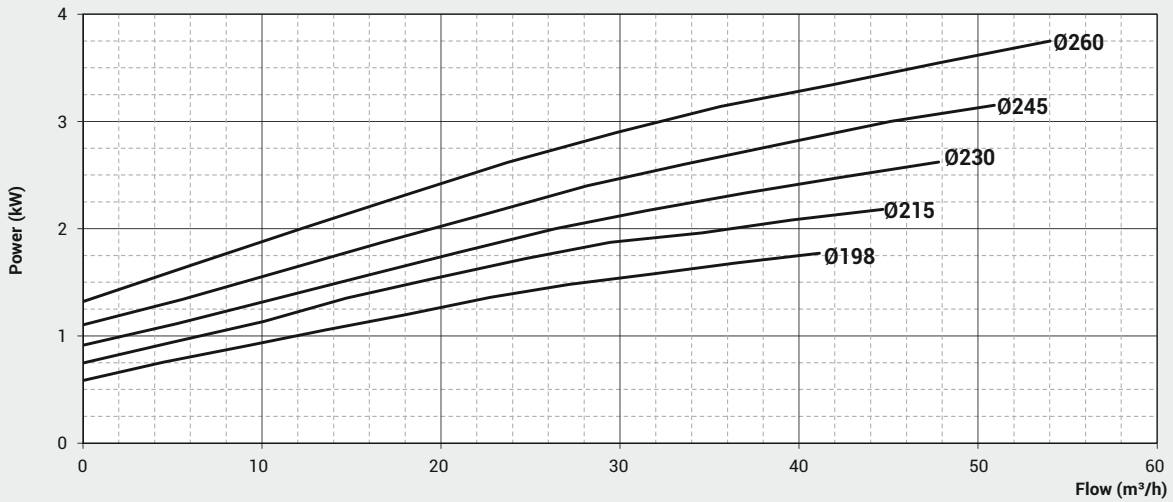
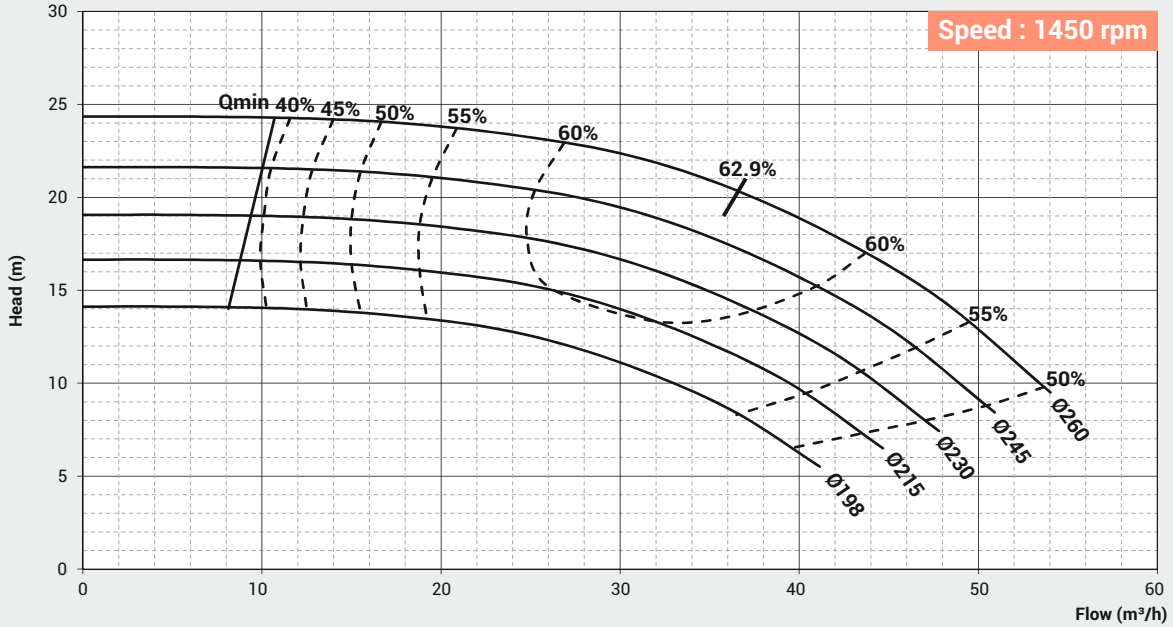

PERFORMANCE CURVE

Pump Model : FIC - 50/250-2

Pump Size in mm : 50 x 50

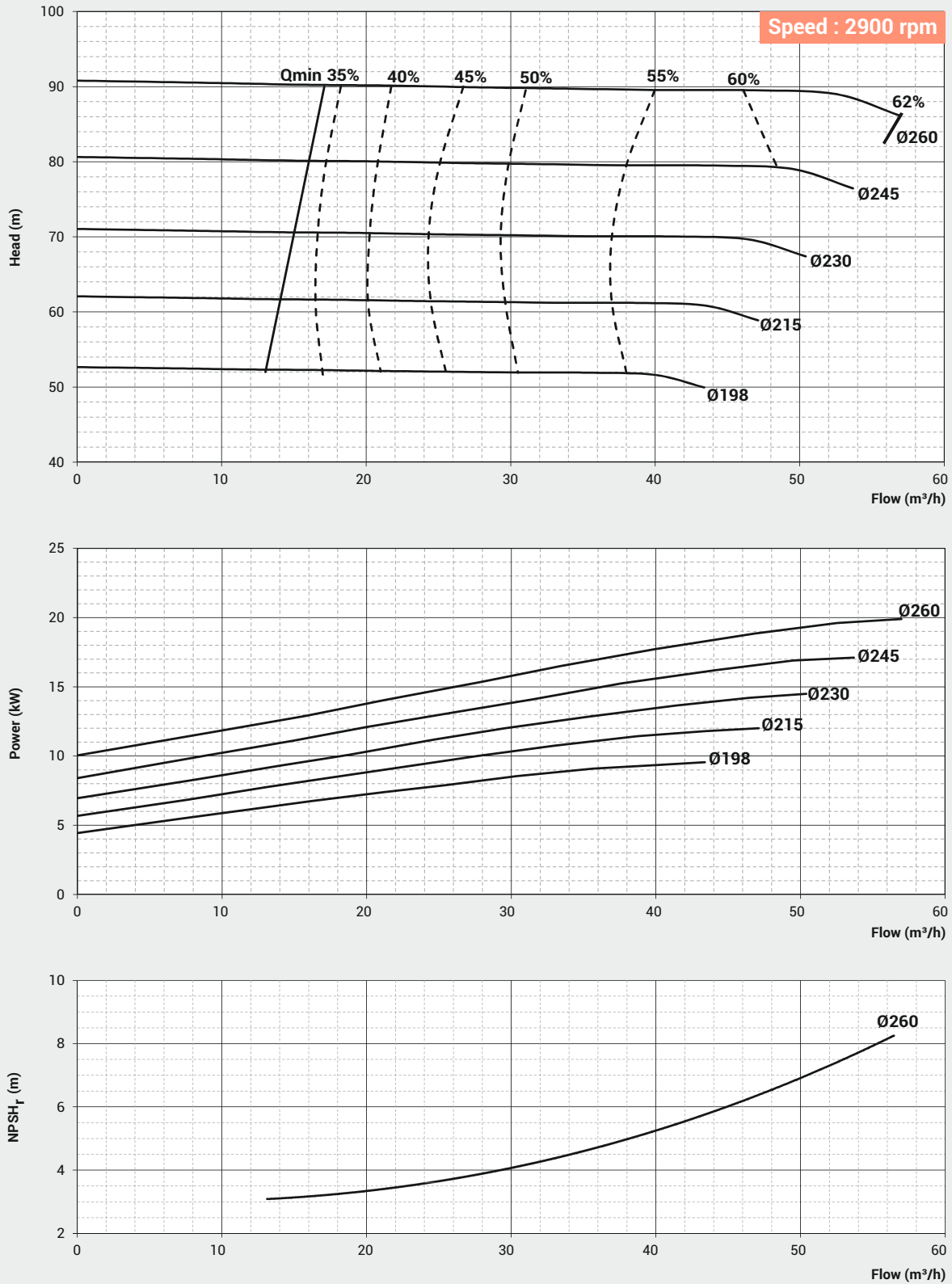

PERFORMANCE CURVE

Pump Model : FIS - 65/160-4 /
FIC - 65/160-4

Pump Size in mm : 65 x 65

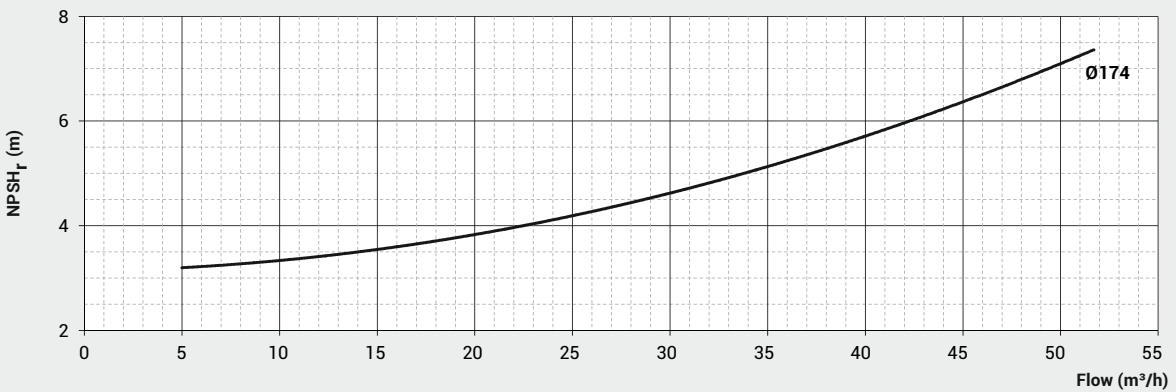
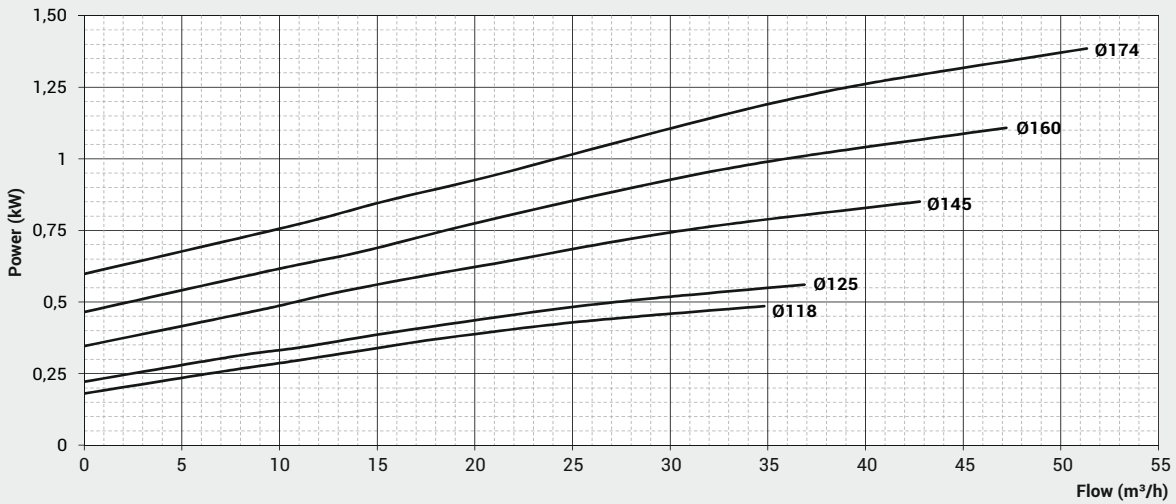
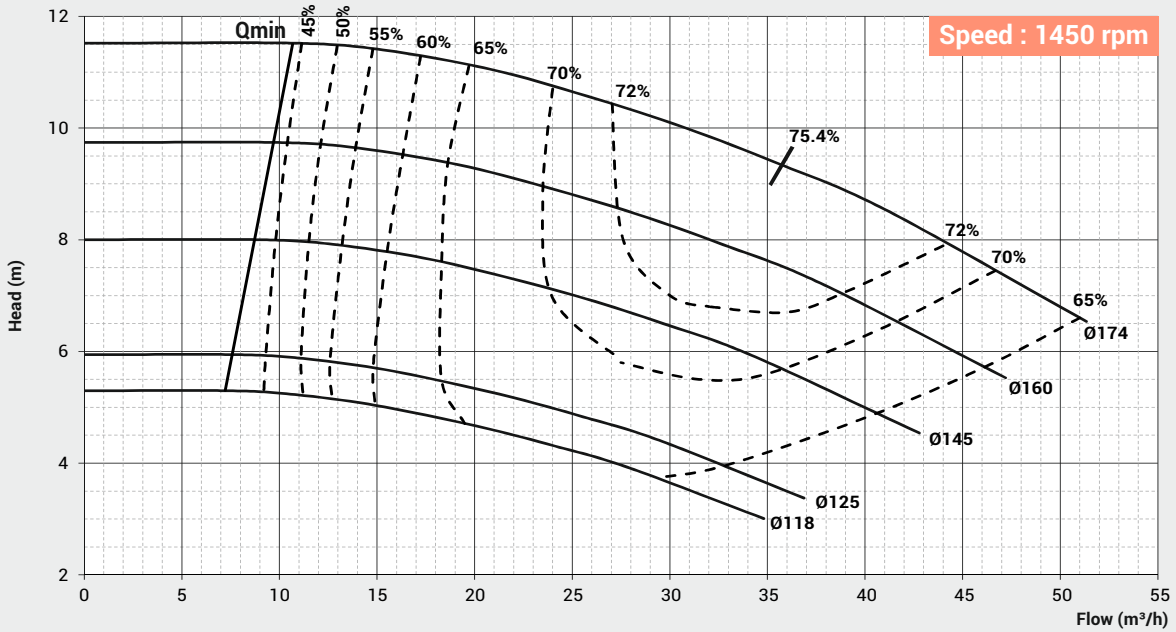

PERFORMANCE CURVE

Pump Model : FIC - 65/160-2

Pump Size in mm : 65 x 65

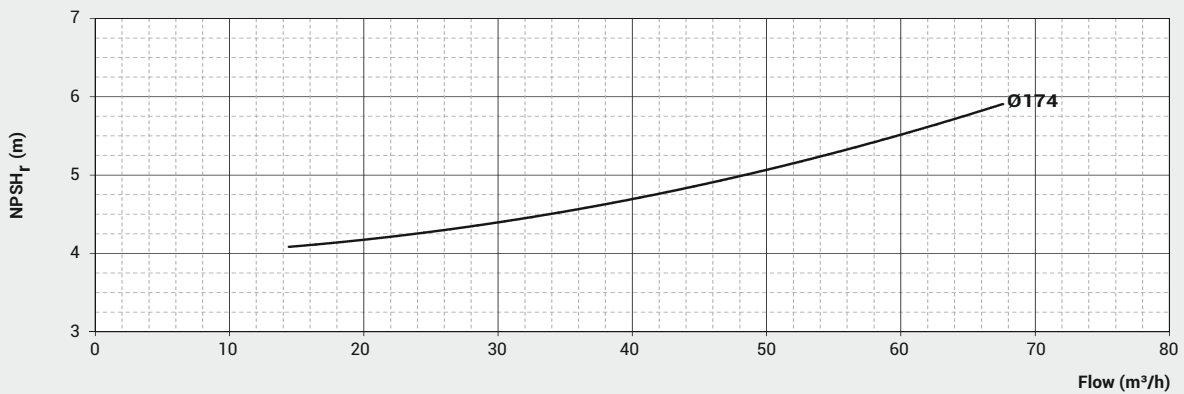
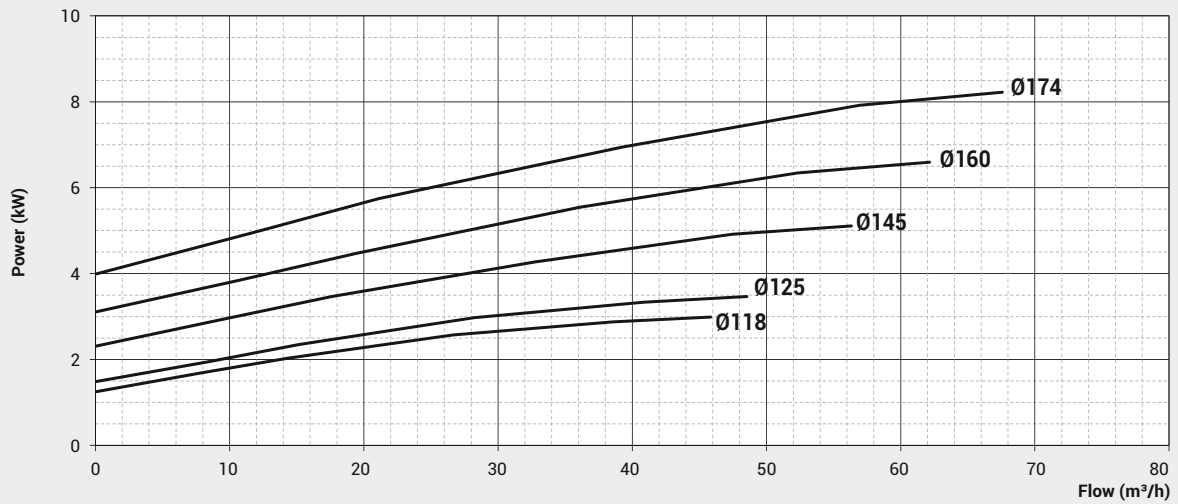
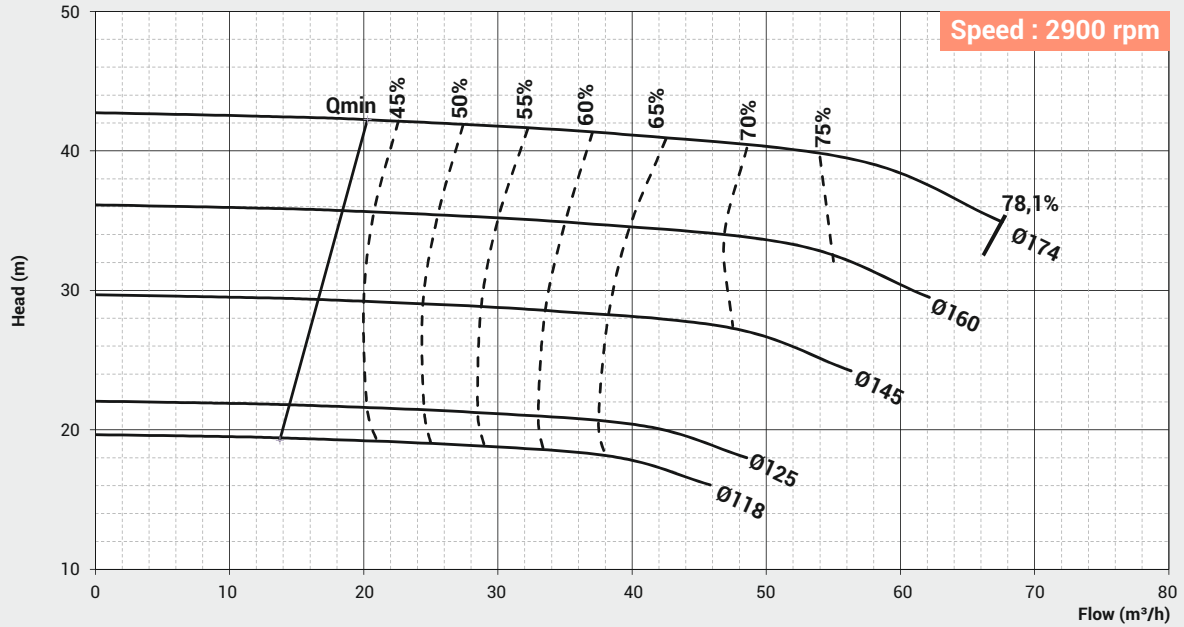

PERFORMANCE CURVE

Pump Model : FIS - 65/250-4 /
FIC - 65/250-4

Pump Size in mm : 65 x 65

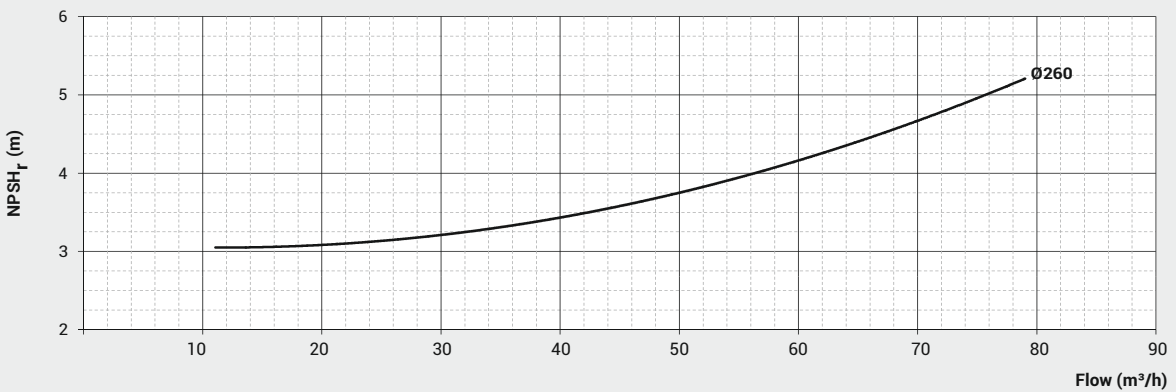
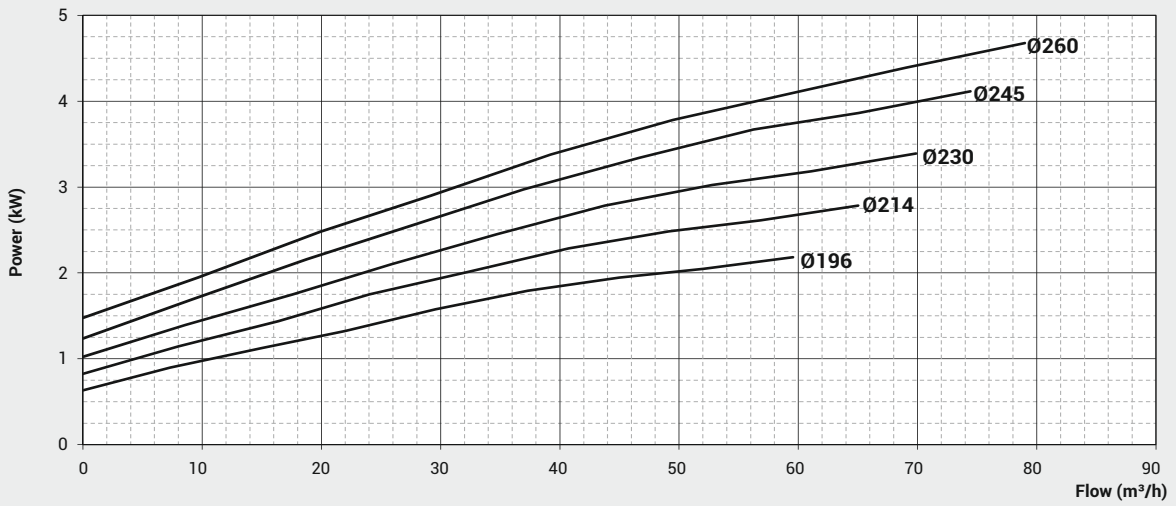
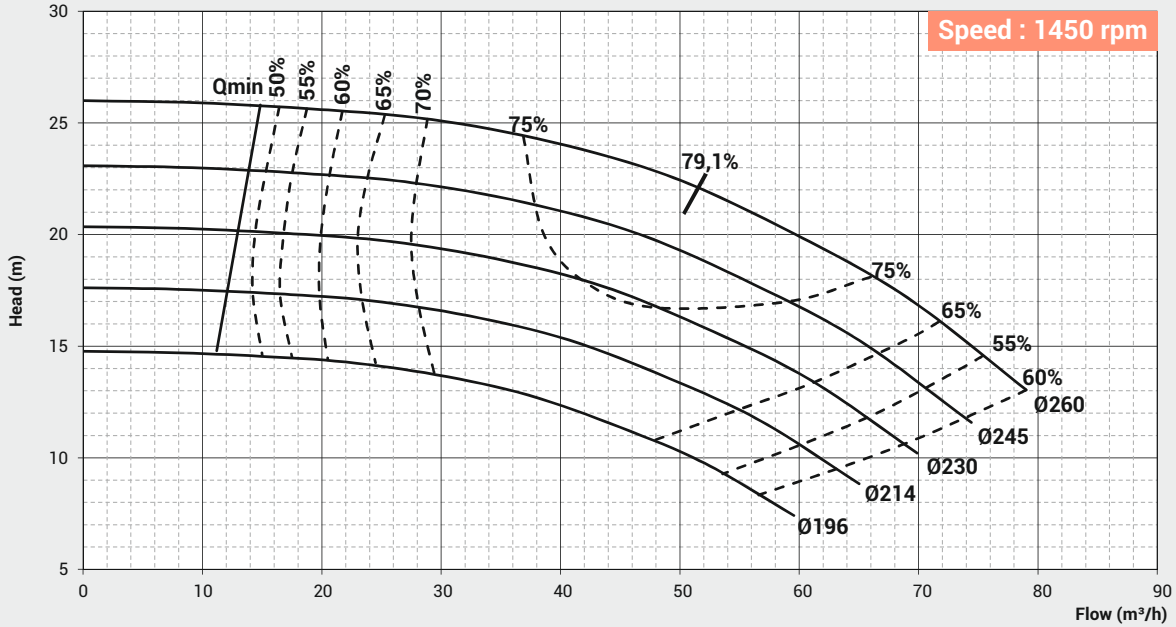

PERFORMANCE CURVE

Pump Model : FIC - 65/250-2

Pump Size in mm : 65 x 65

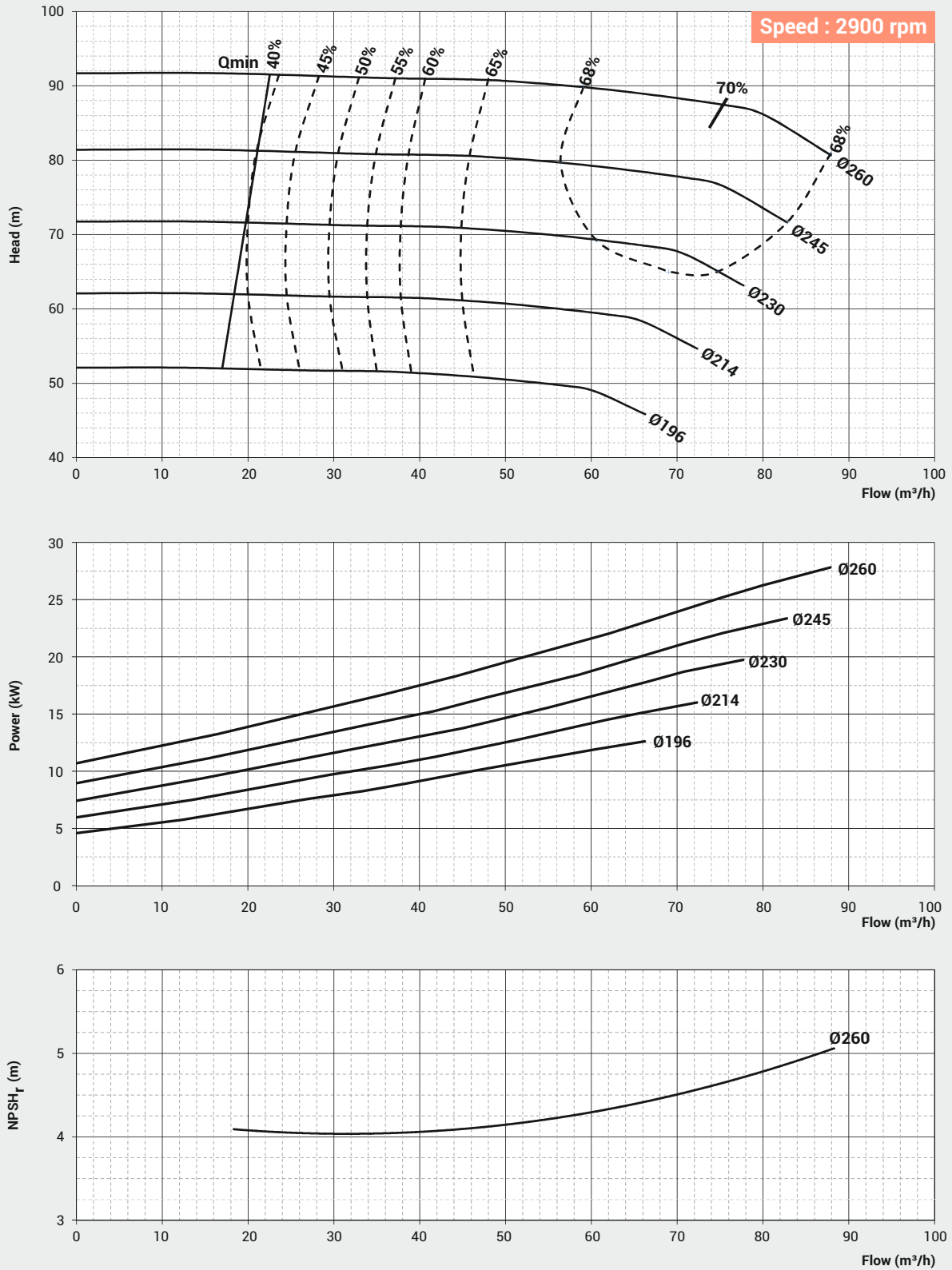

PERFORMANCE CURVE

Pump Model : FIS - 80/160-4 /
FIC - 80/160-4

Pump Size in mm : 80 x 80

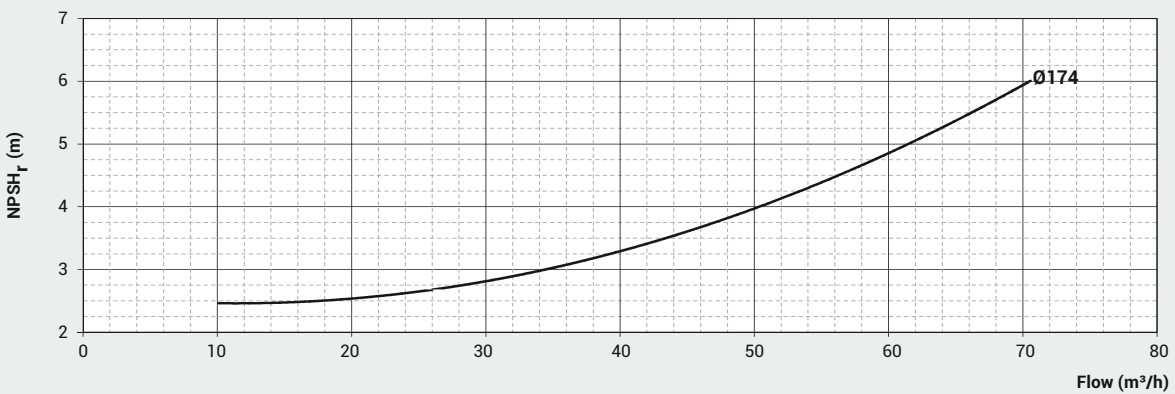
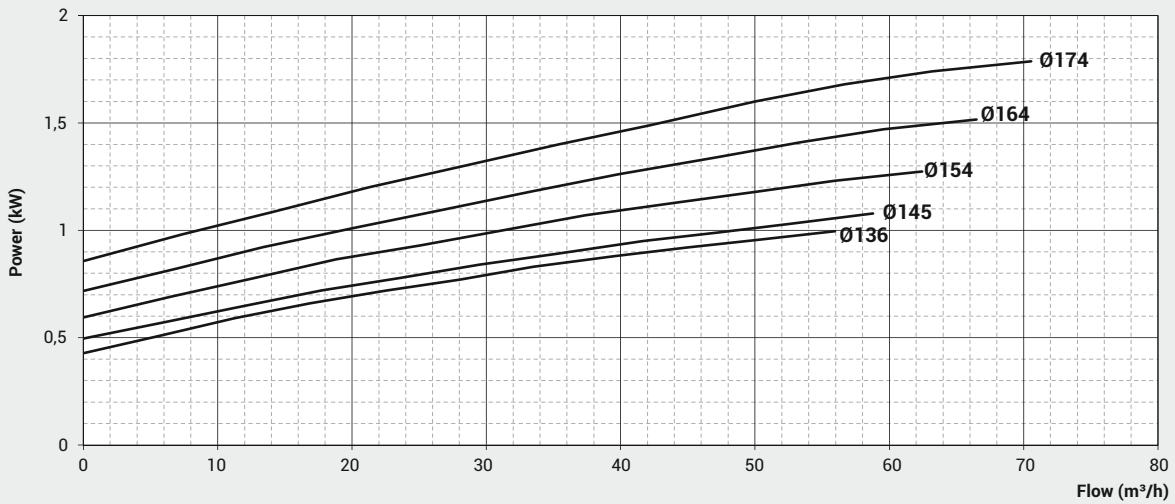
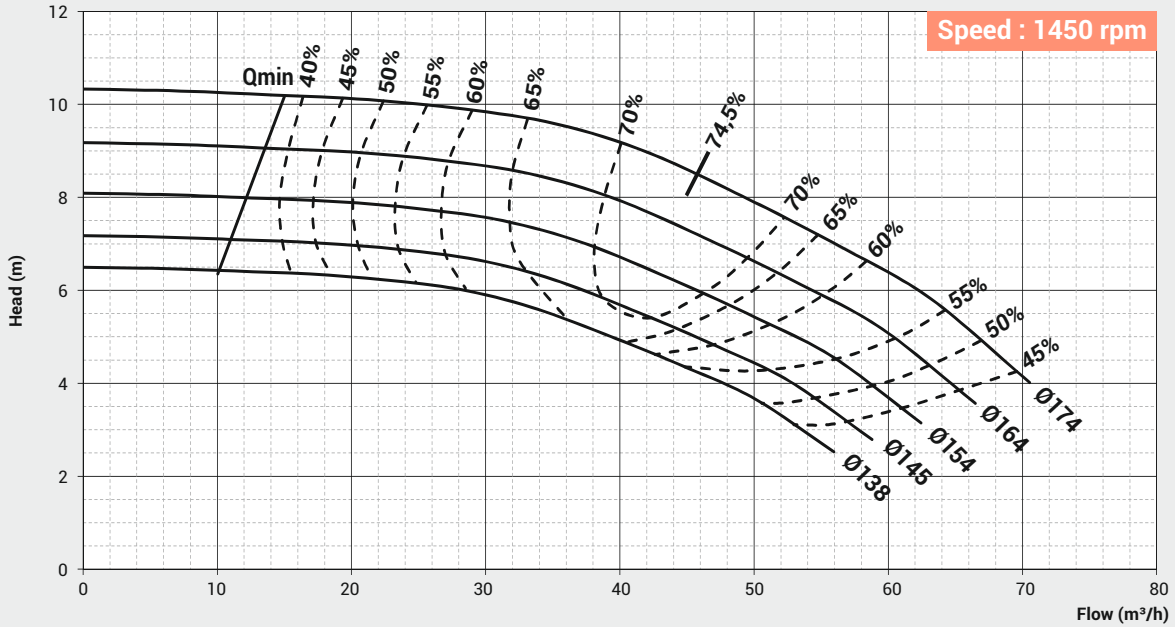

PERFORMANCE CURVE

Pump Model : FIC - 80/160-2

Pump Size in mm : 80 x 80

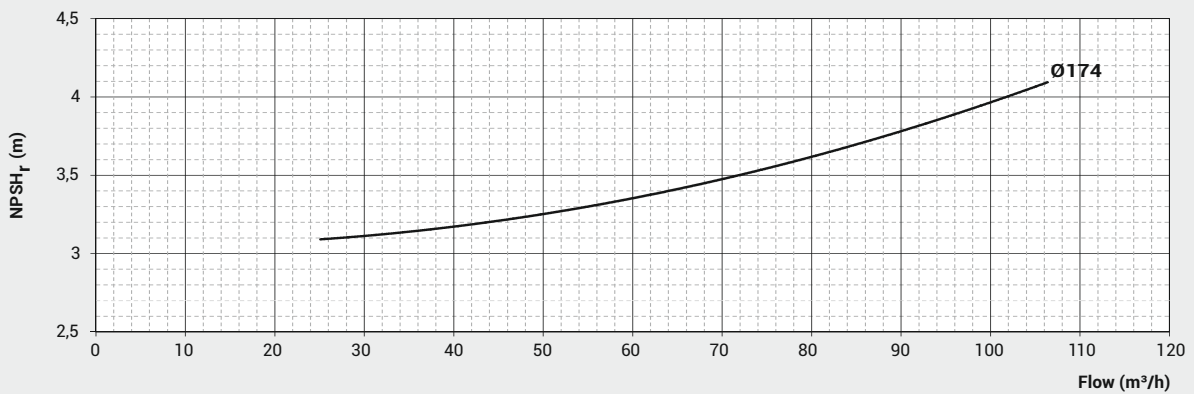
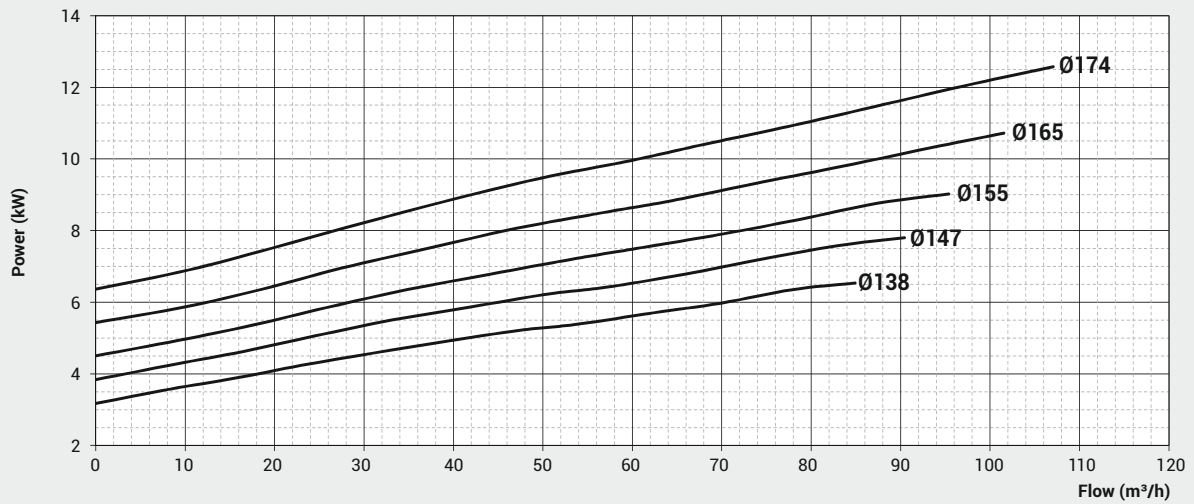
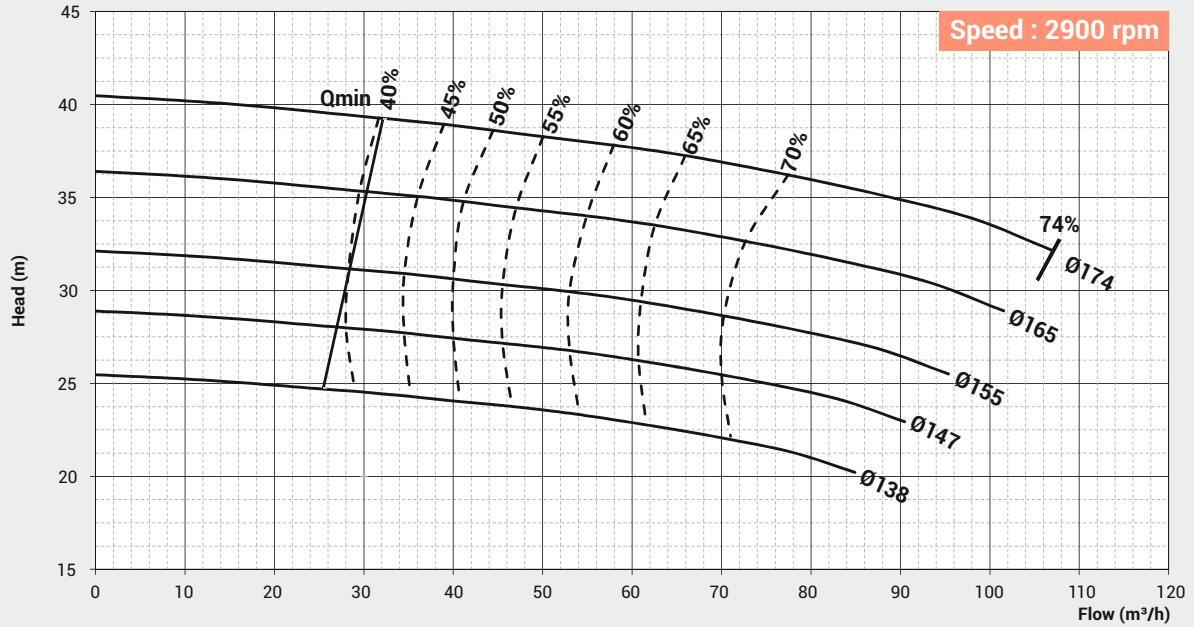

PERFORMANCE CURVE

Pump Model : FIS - 80/200-4 /
FIC - 80/200-4

Pump Size in mm : 80 x 80

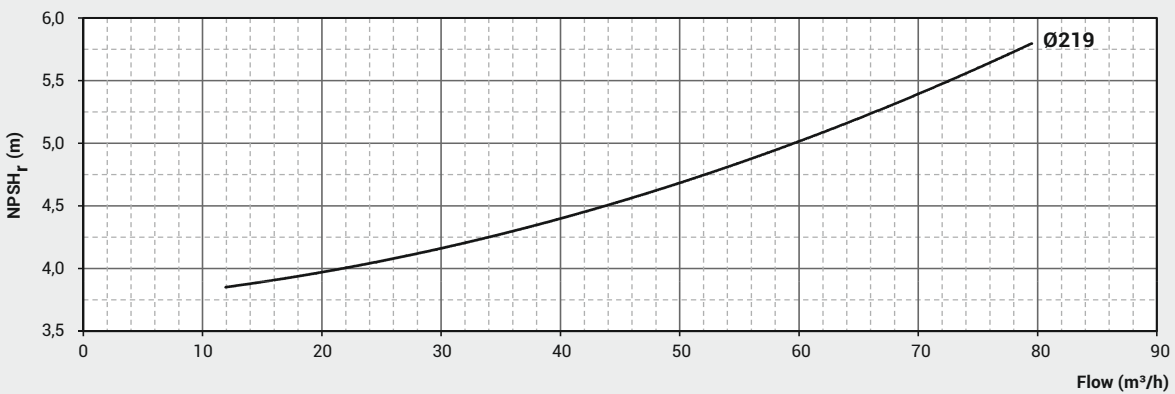
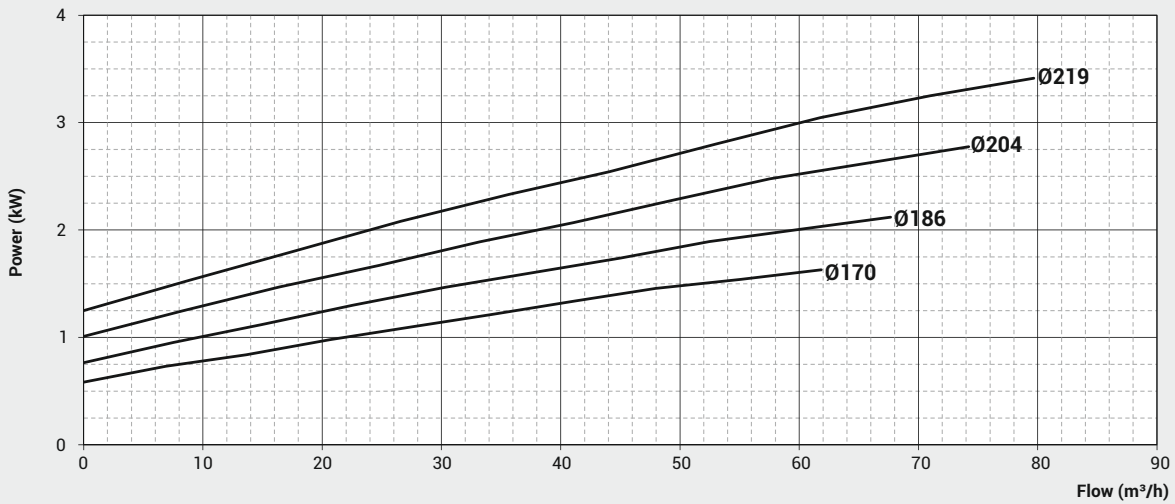
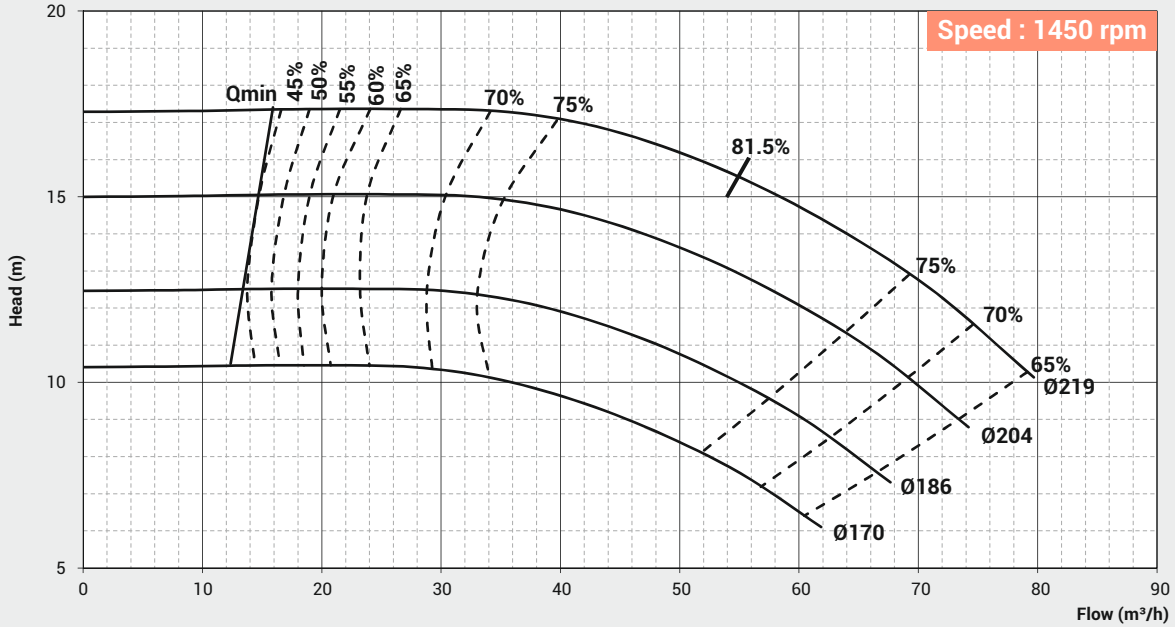

PERFORMANCE CURVE

Pump Model : FIC - 80/200-2

Pump Size in mm : 80 x 80

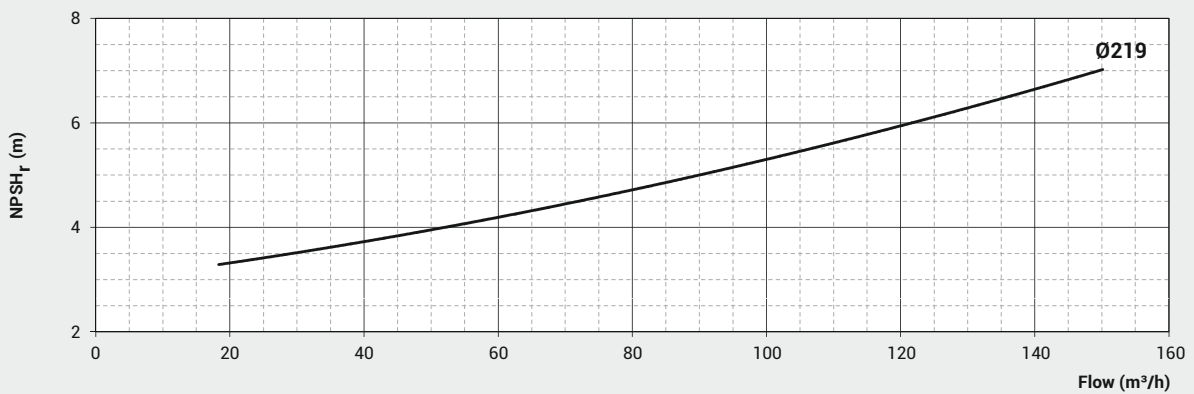
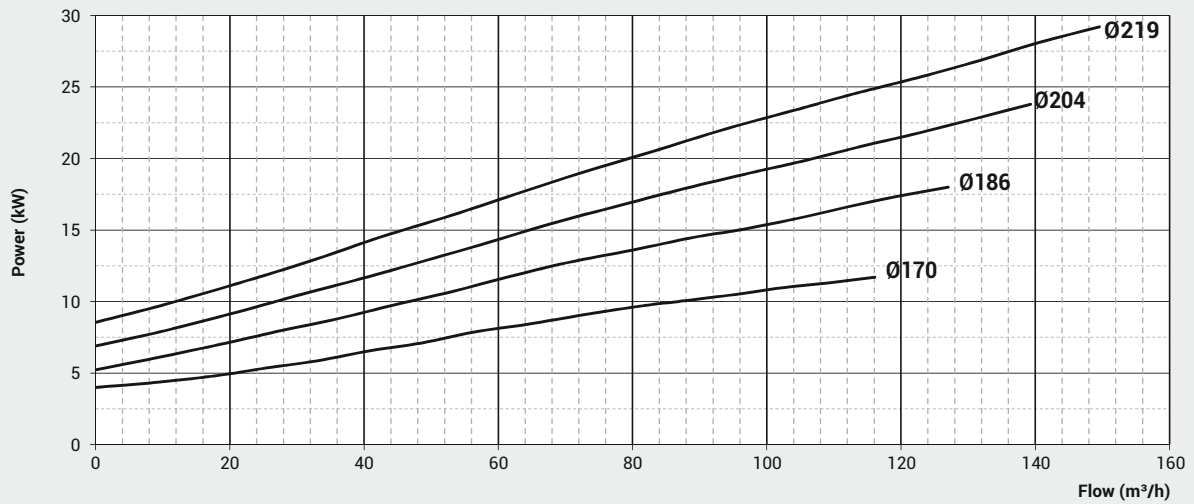
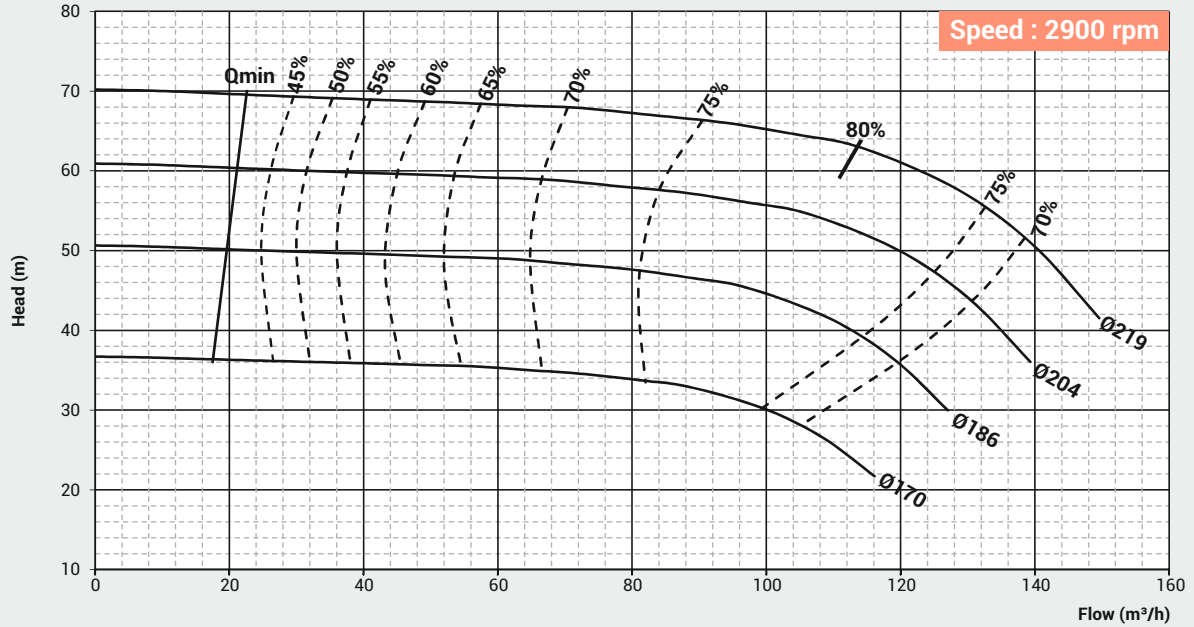

PERFORMANCE CURVE

Pump Model : FIS - 80/250-4 /
FIC - 80/250-4

Pump Size in mm : 80 x 80

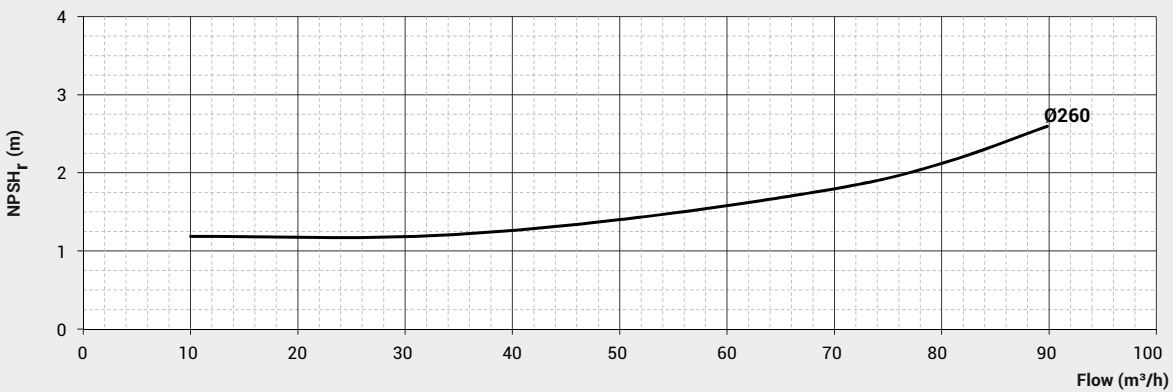
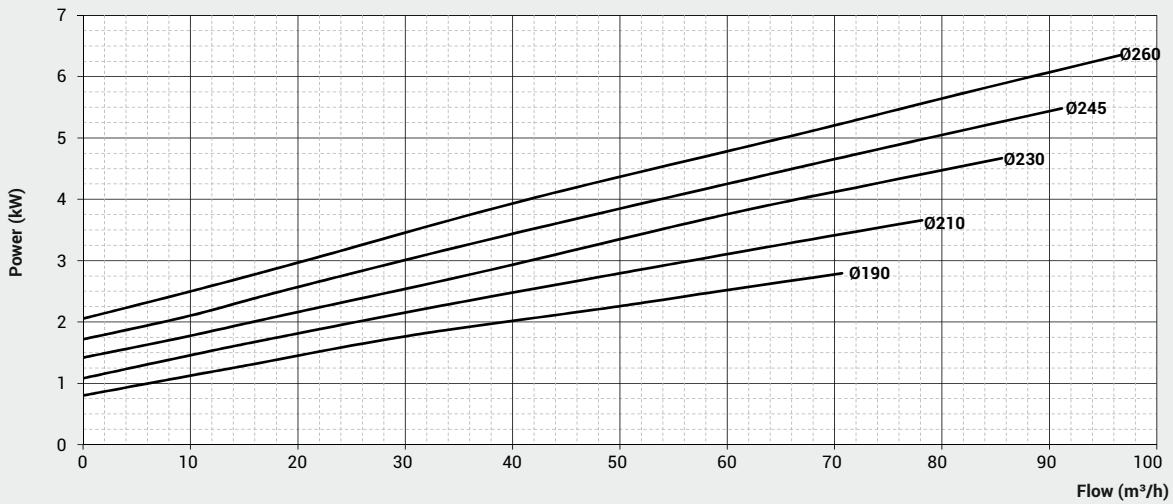
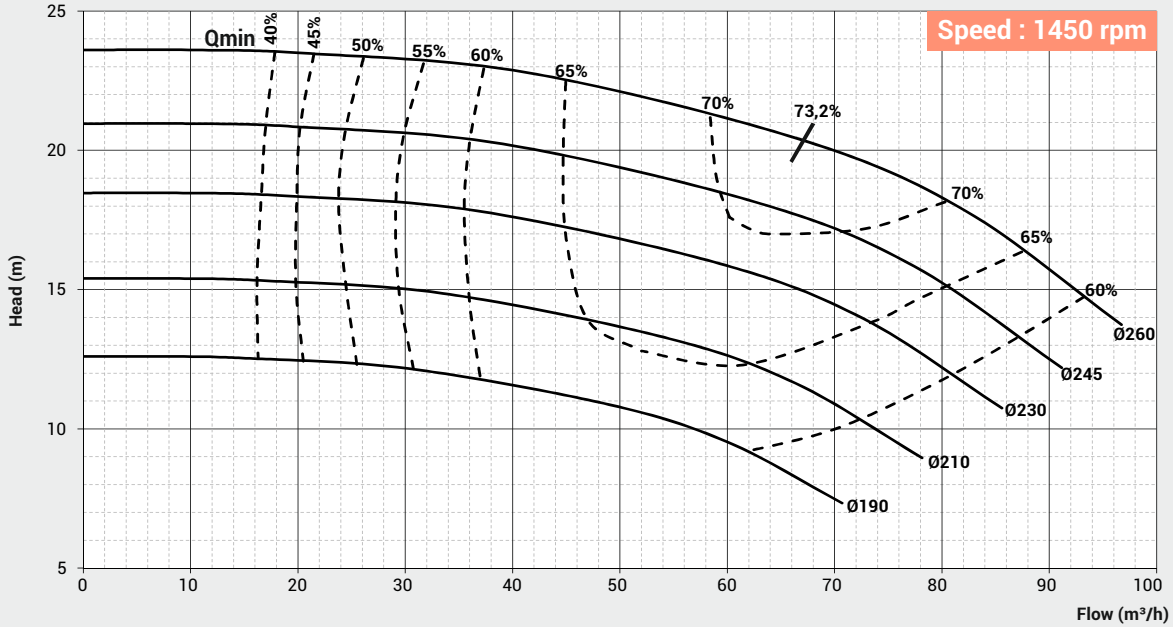

PERFORMANCE CURVE

Pump Model : FIS - 80/360-4 /
FIC - 80/360-4

Pump Size in mm : 80 x 80

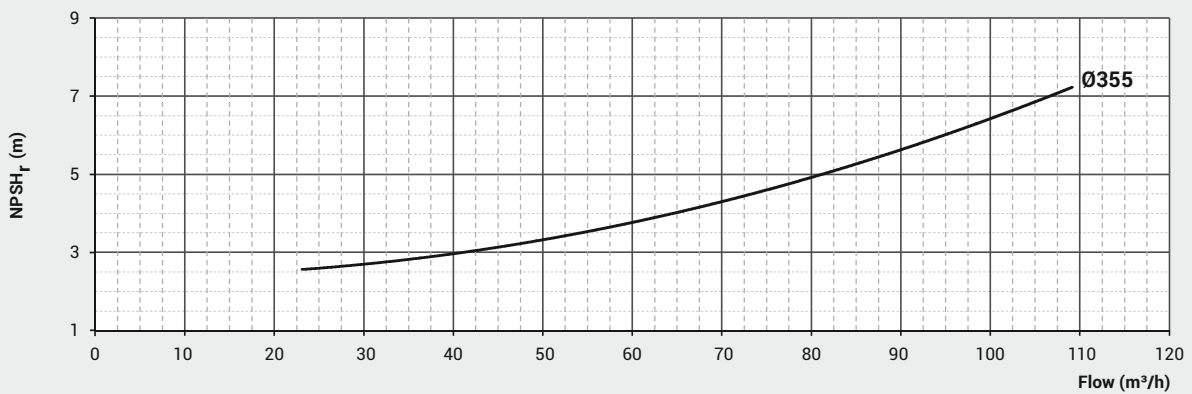
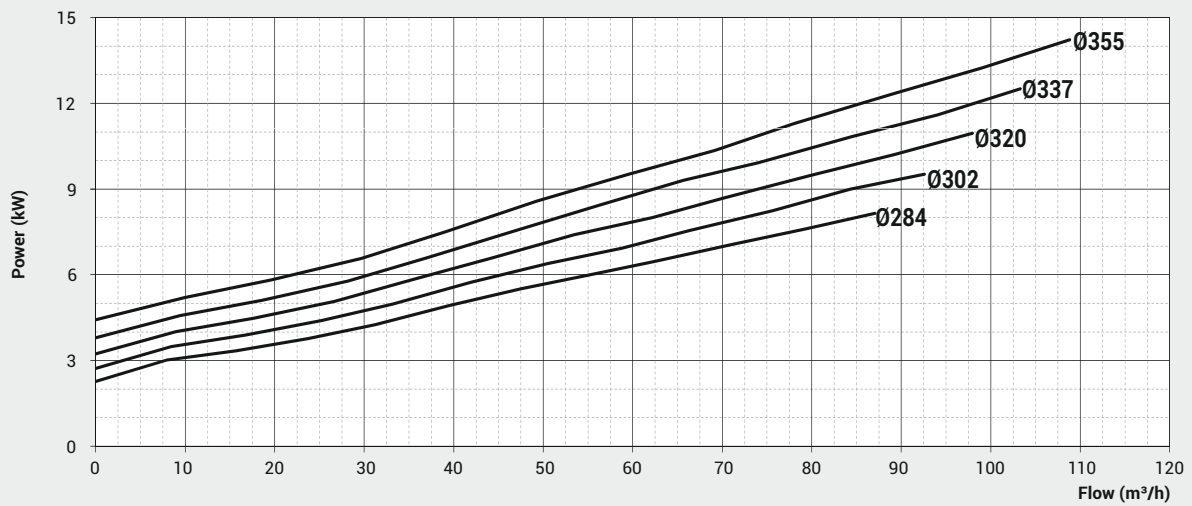
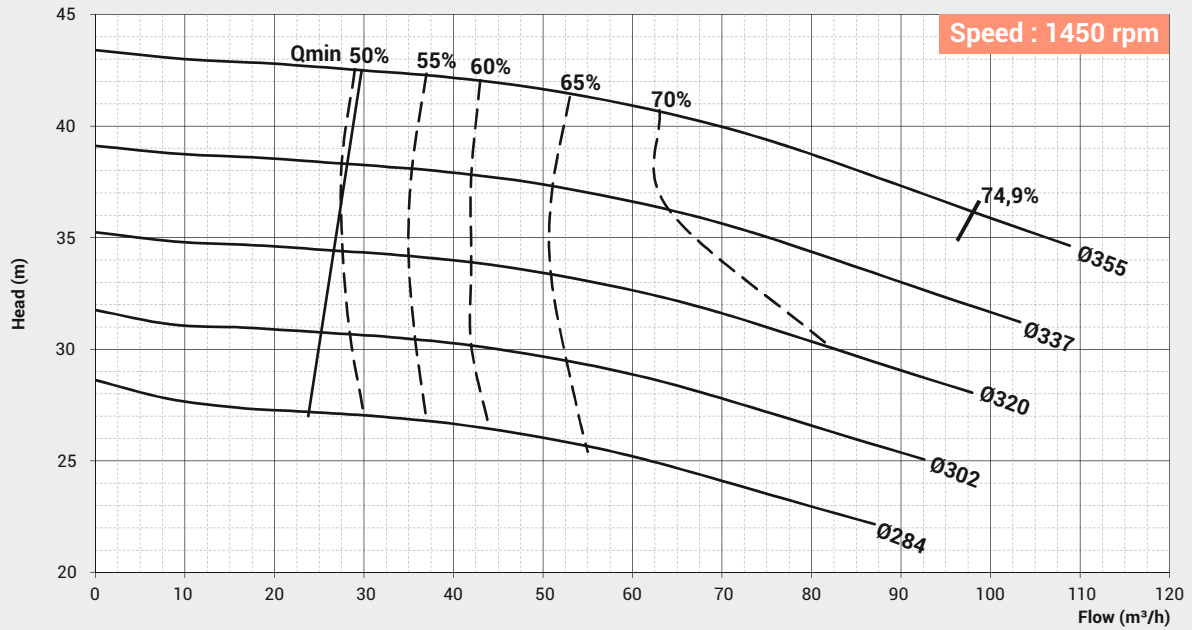

PERFORMANCE CURVE

Pump Model : FIS - 100/200-4 /
FIC - 100/200-4

Pump Size in mm : 100 x 100

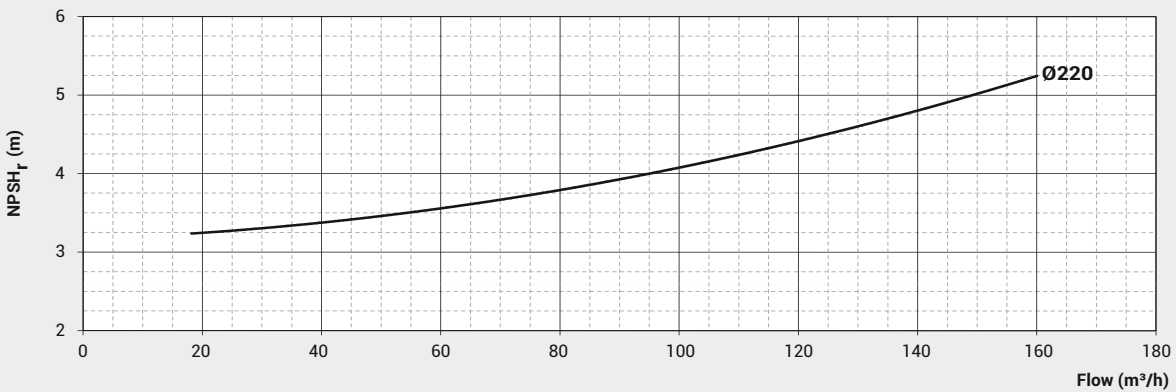
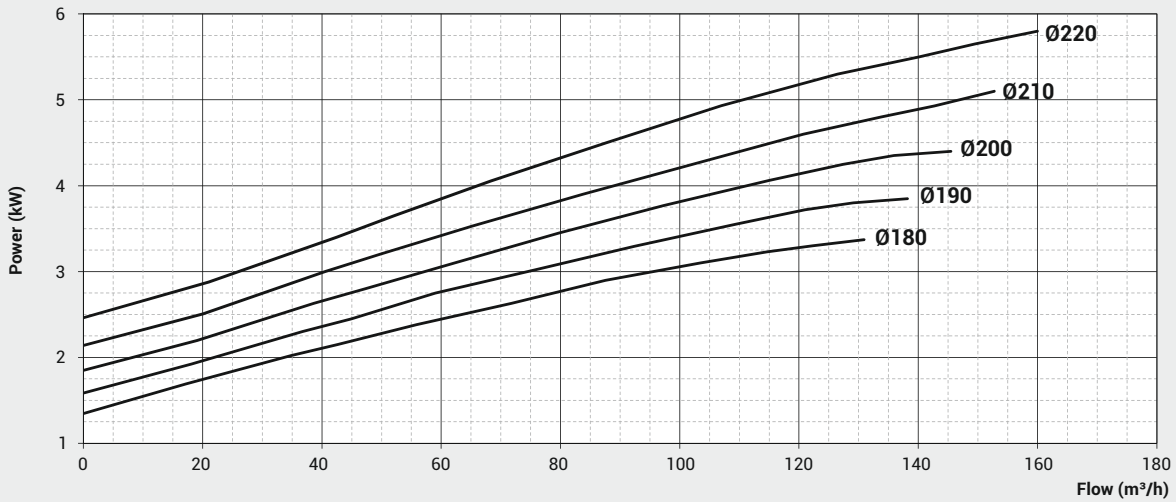
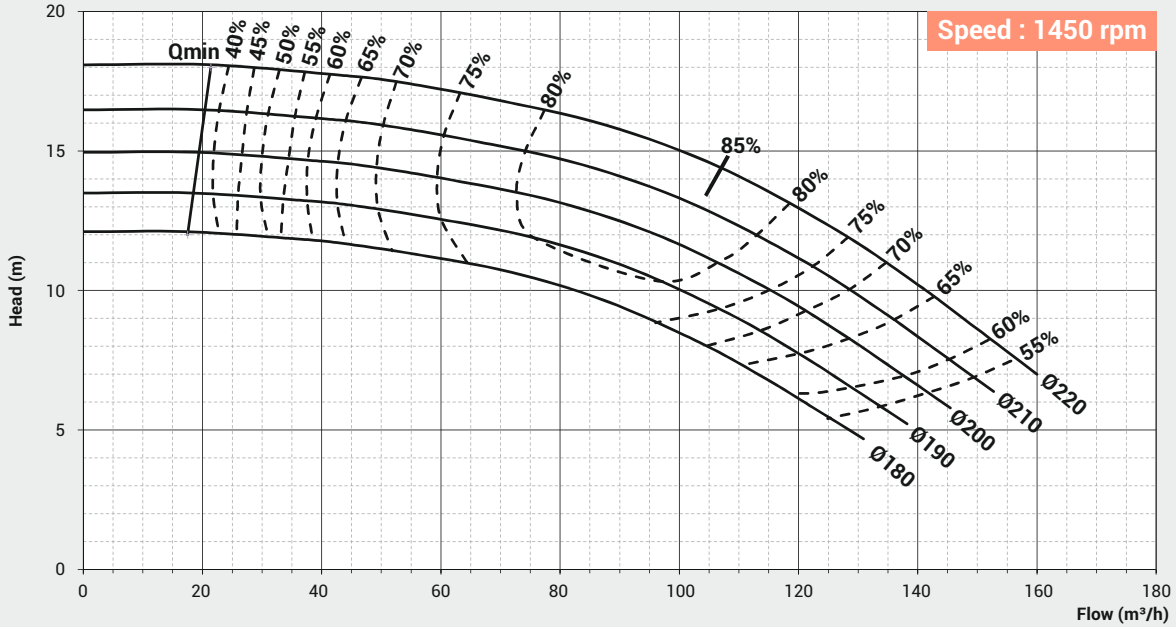

PERFORMANCE CURVE

Pump Model : FIC - 100/200-2

Pump Size in mm : 100 x 100

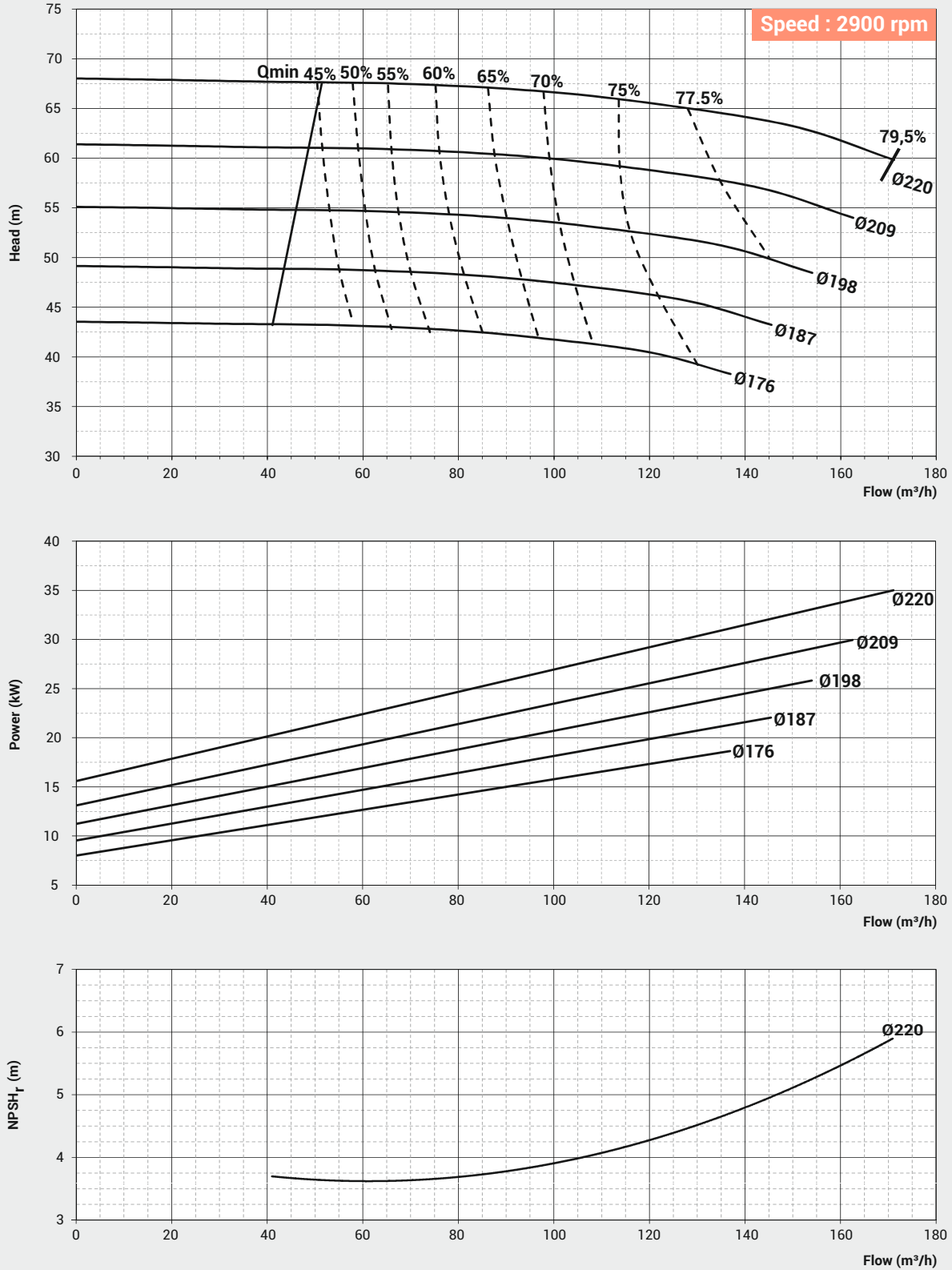

PERFORMANCE CURVE

Pump Model : FIS - 100/250-4
FIC - 100/250-4

Pump Size in mm : 100 x 100

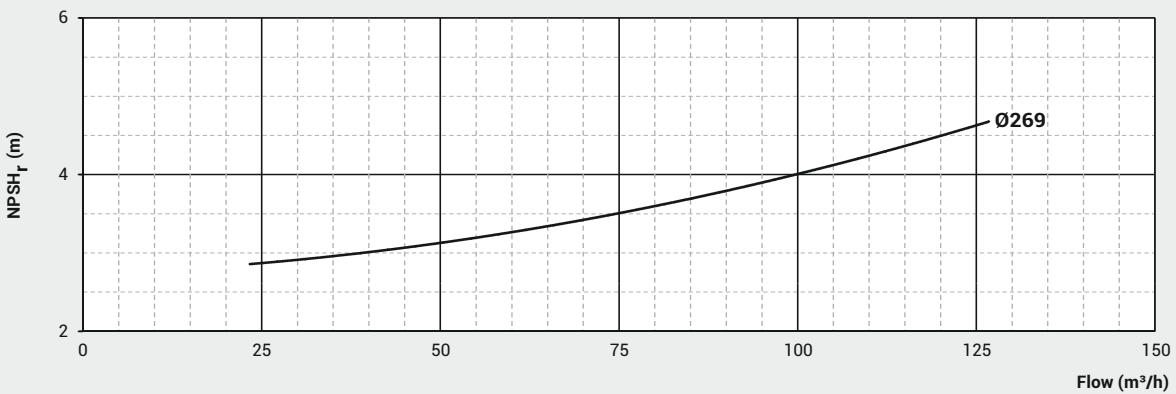
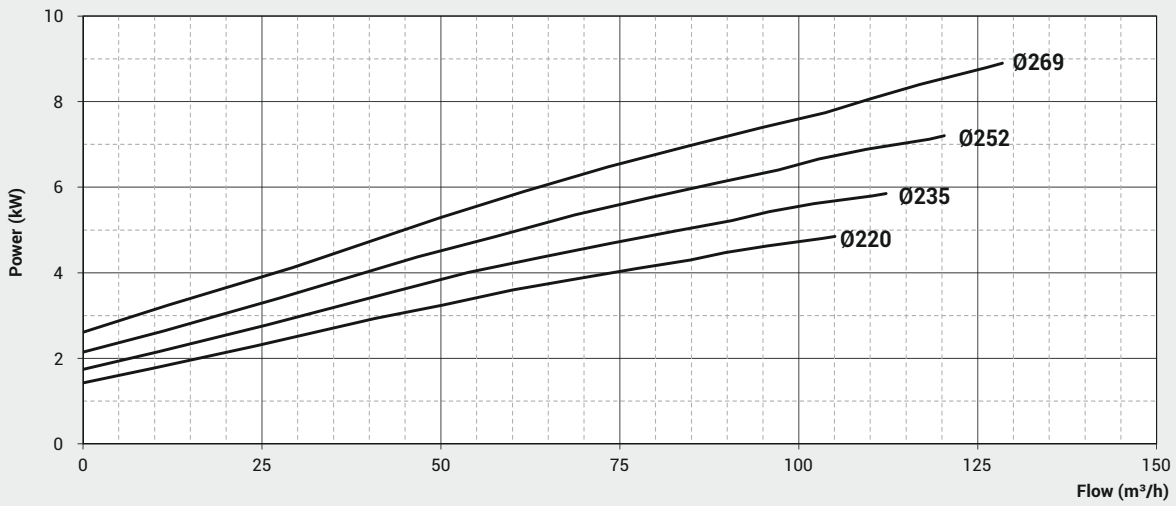
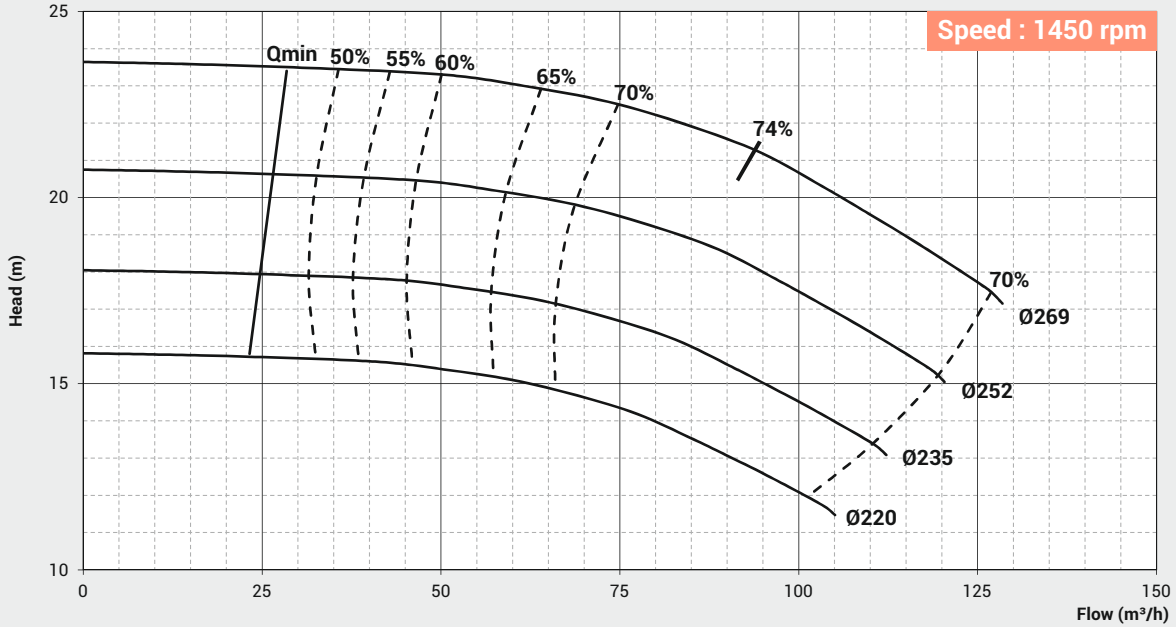

PERFORMANCE CURVE

Pump Model : FIS - 100/380-4 /
FIC - 100/380-4

Pump Size in mm : 100 x 100

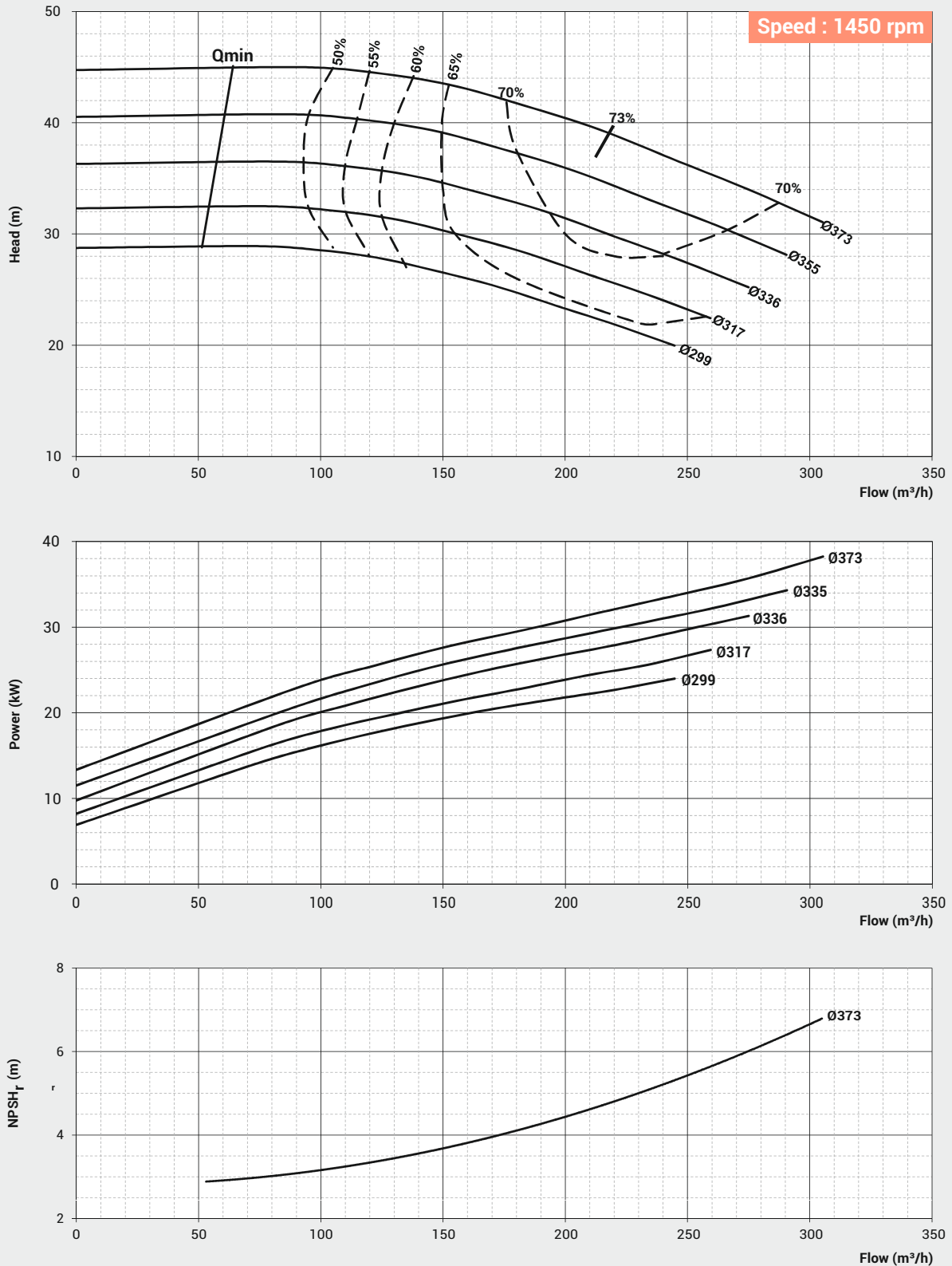

PERFORMANCE CURVE

Pump Model : FIS - 80/250-4 /
FIC - 80/250-4

Pump Size in mm : 100 x 100

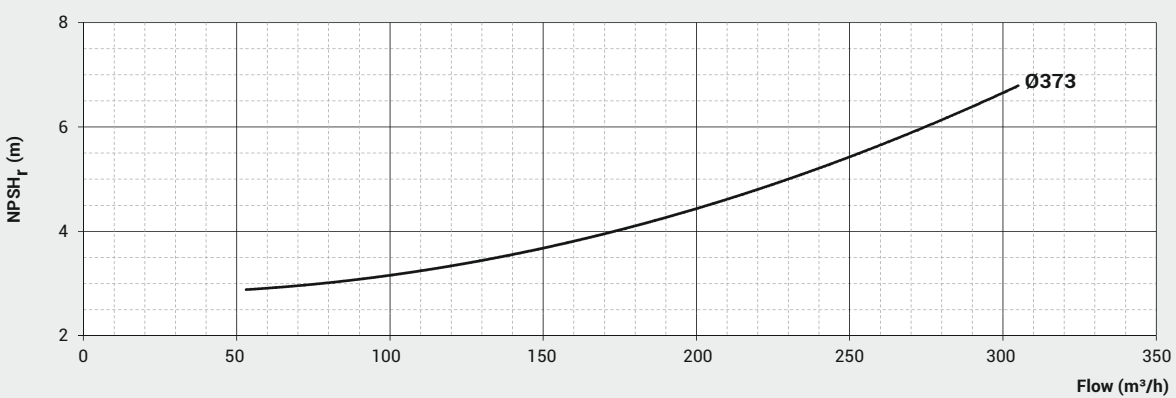
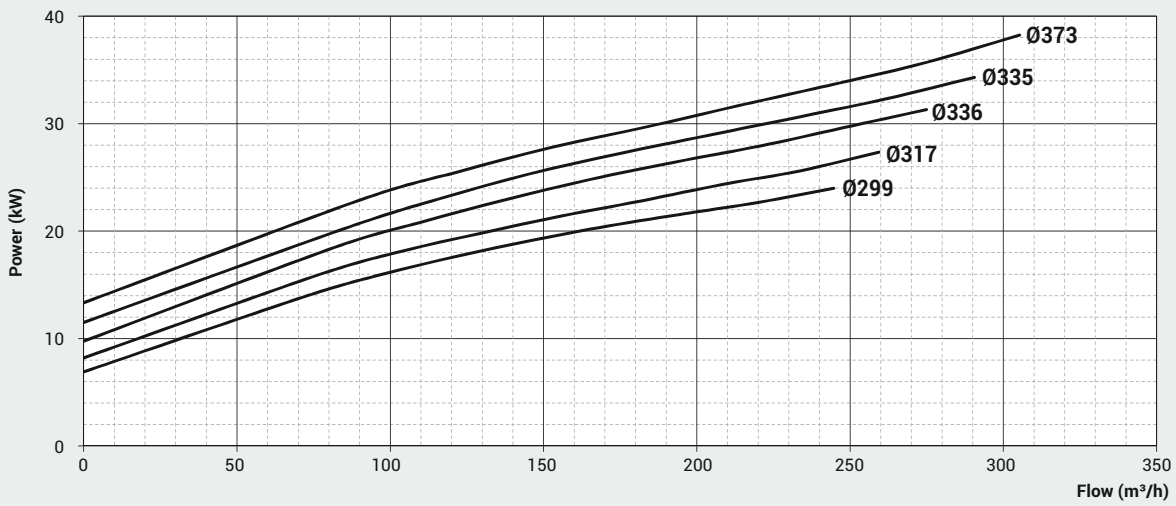
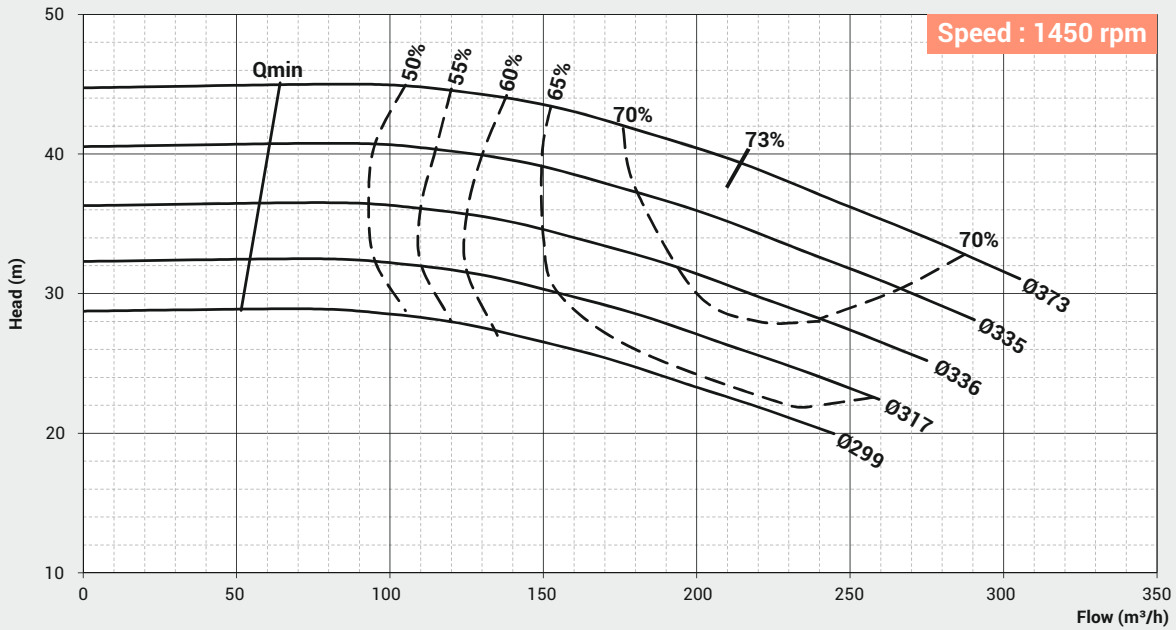

PERFORMANCE CURVE

Pump Model : FIS - 100/400-4 /
FIC - 100/400-4

Pump Size in mm : 100 x 100

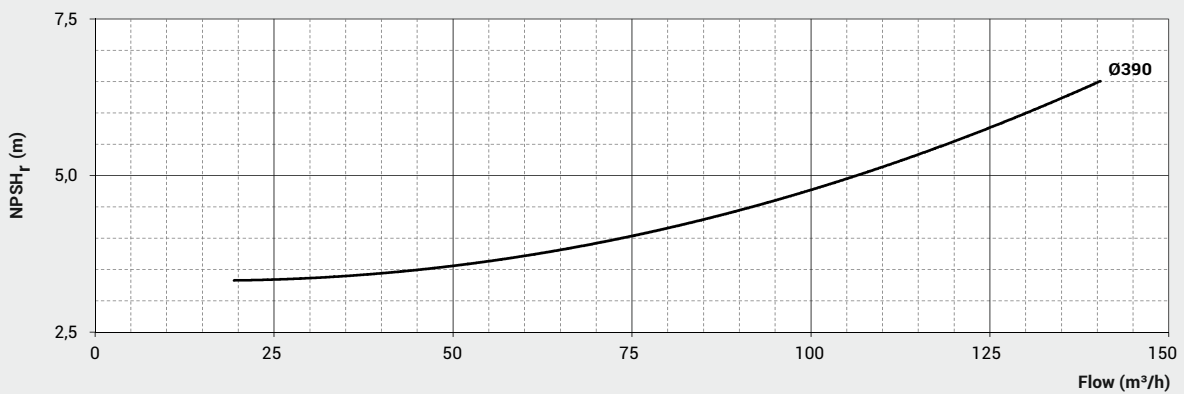
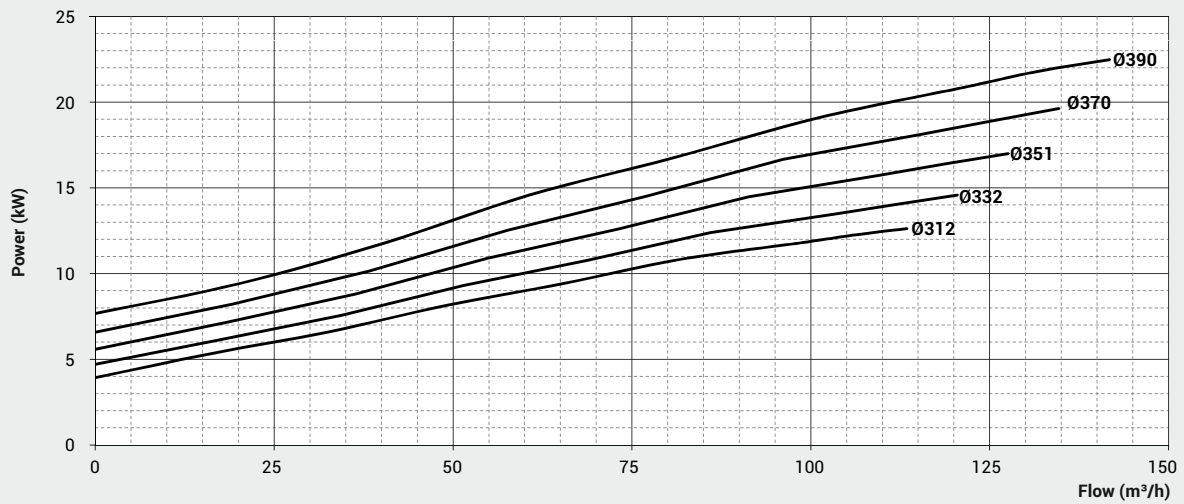
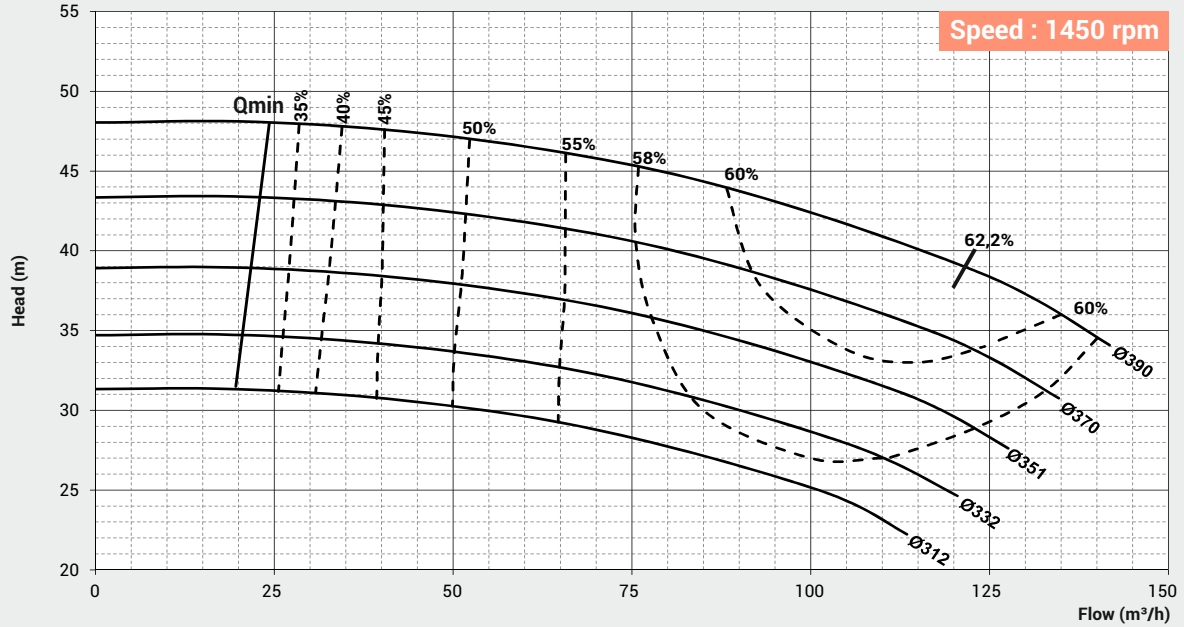

PERFORMANCE CURVE

Pump Model : FIS - 125/200-4 /
FIC - 125/200-4

Pump Size in mm : 125 x 125

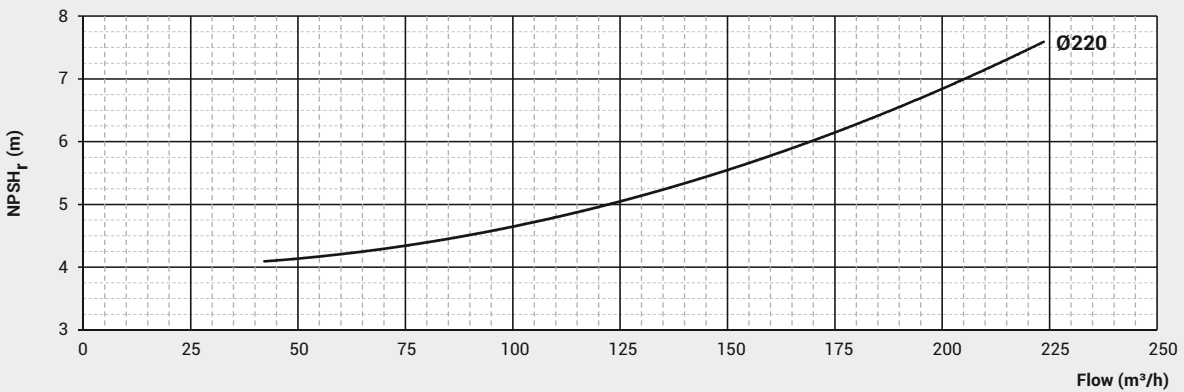
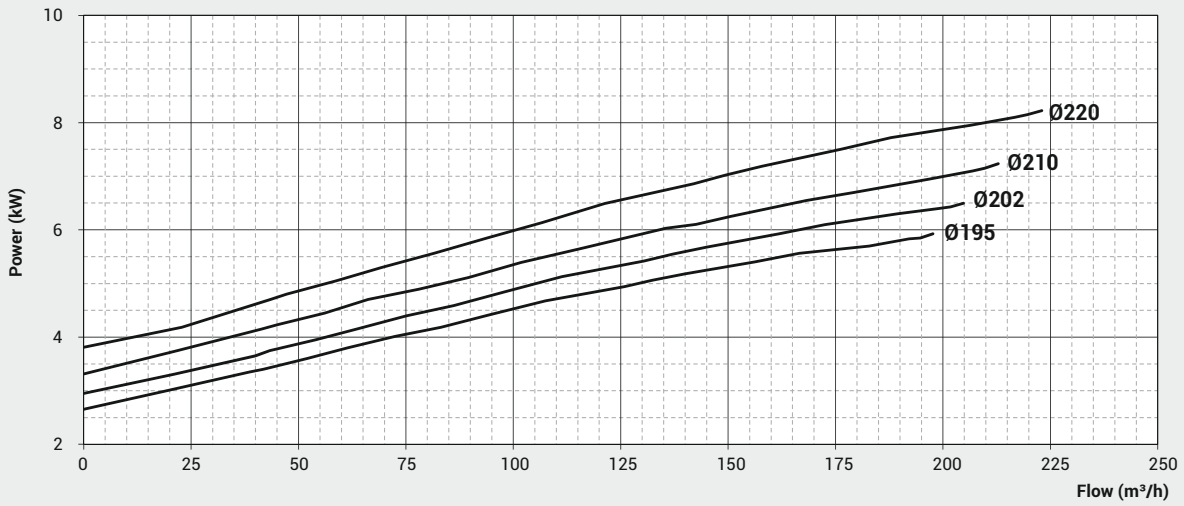
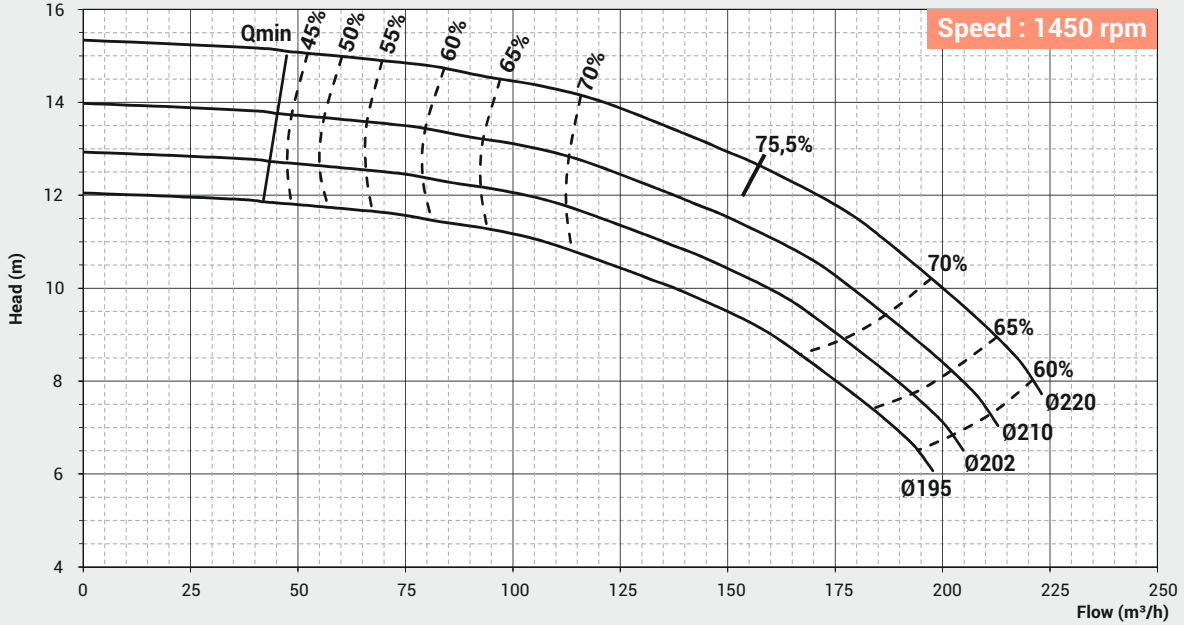

PERFORMANCE CURVE

Pump Model : FIC - 125/200-2

Pump Size in mm : 125 x 125

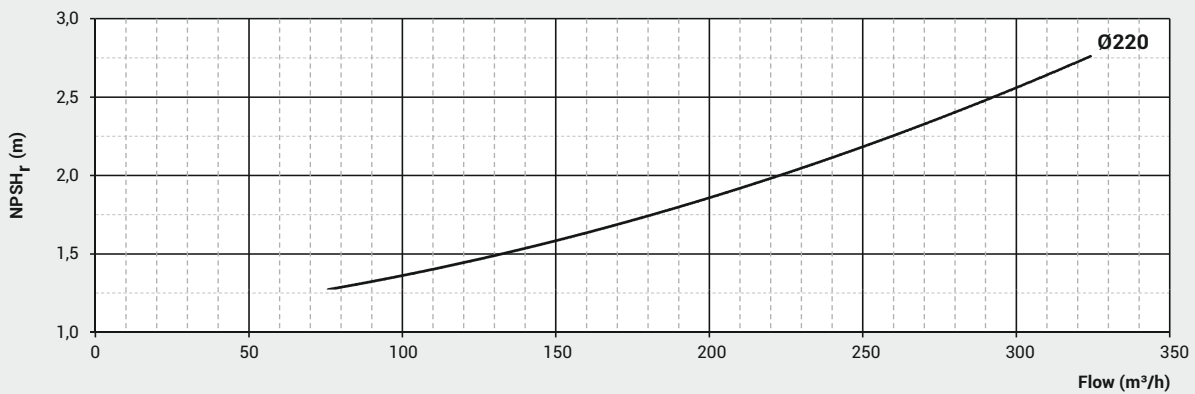
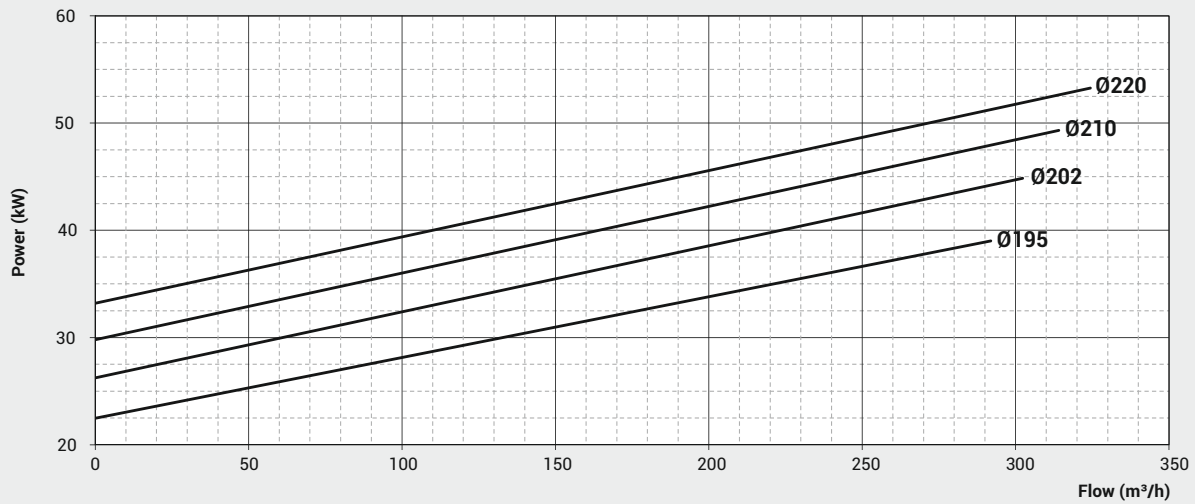
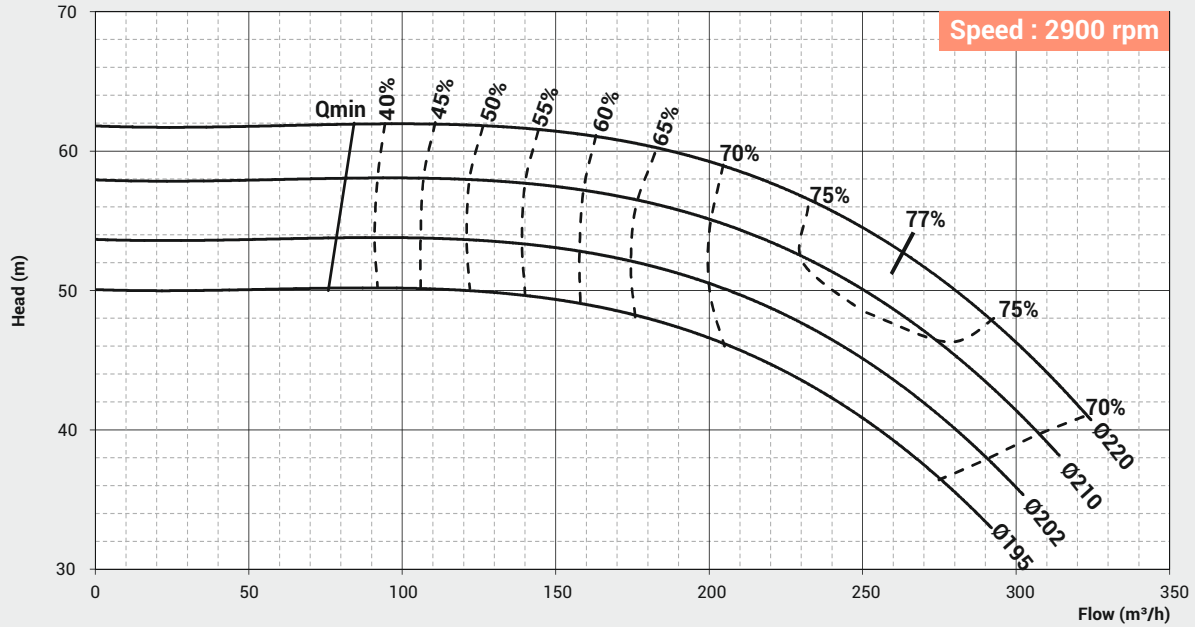

PERFORMANCE CURVE

Pump Model : FIS - 125/250-4 /
FIC - 125/250-4

Pump Size in mm : 125 x 125

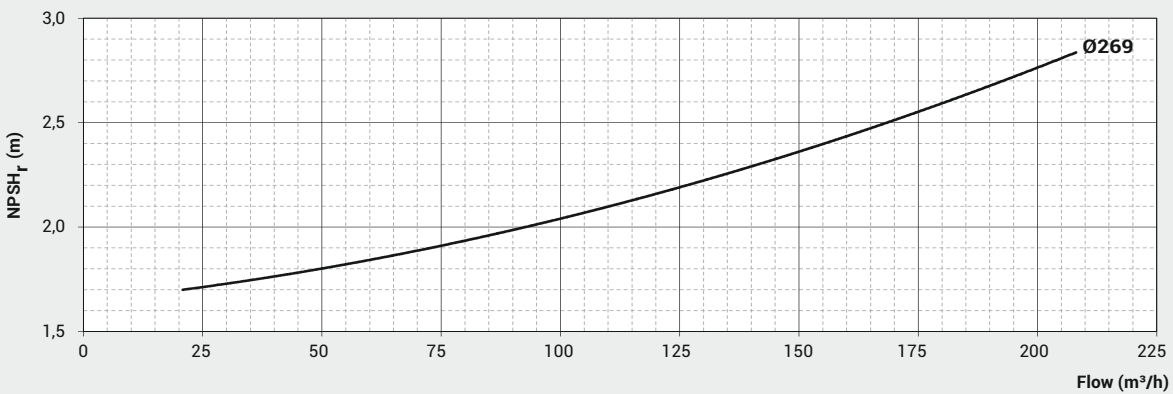
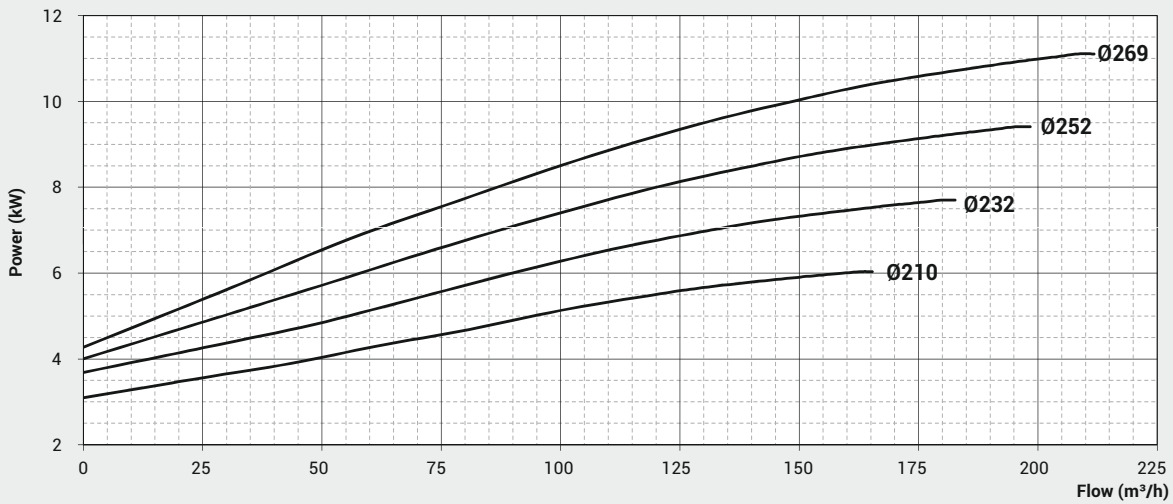
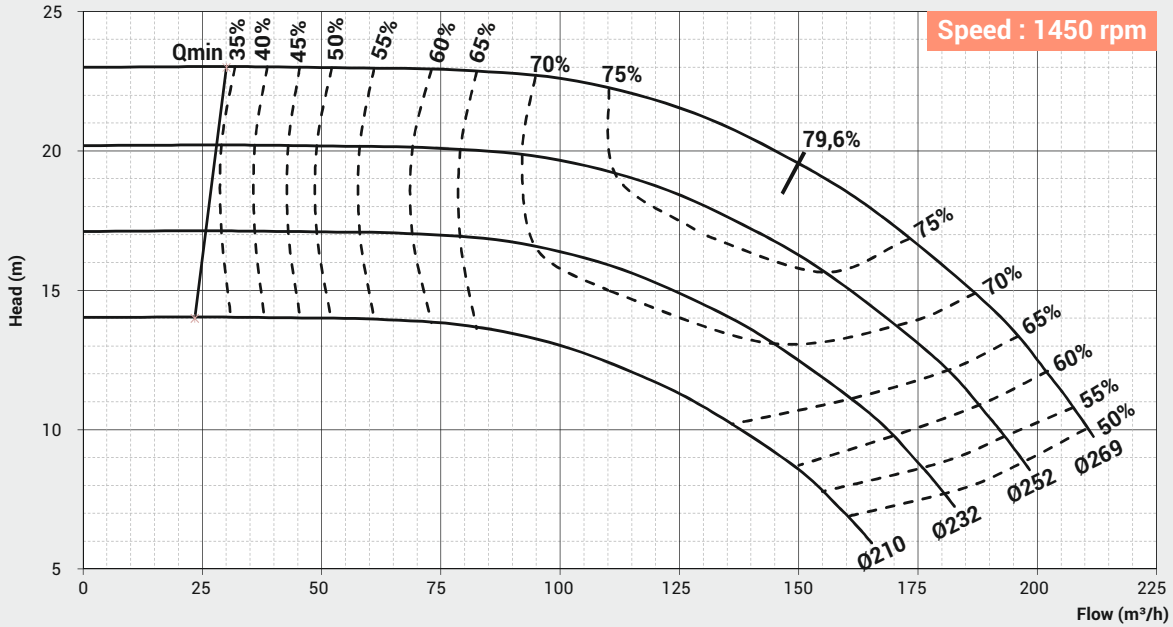

PERFORMANCE CURVE

Pump Model : FIS - 150/200-4 /
FIC - 150/200-4

Pump Size in mm : 150 x 150

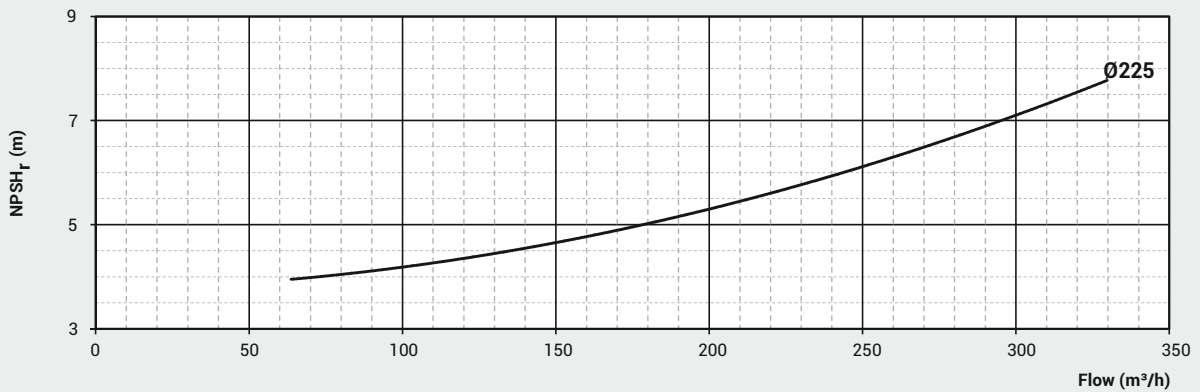
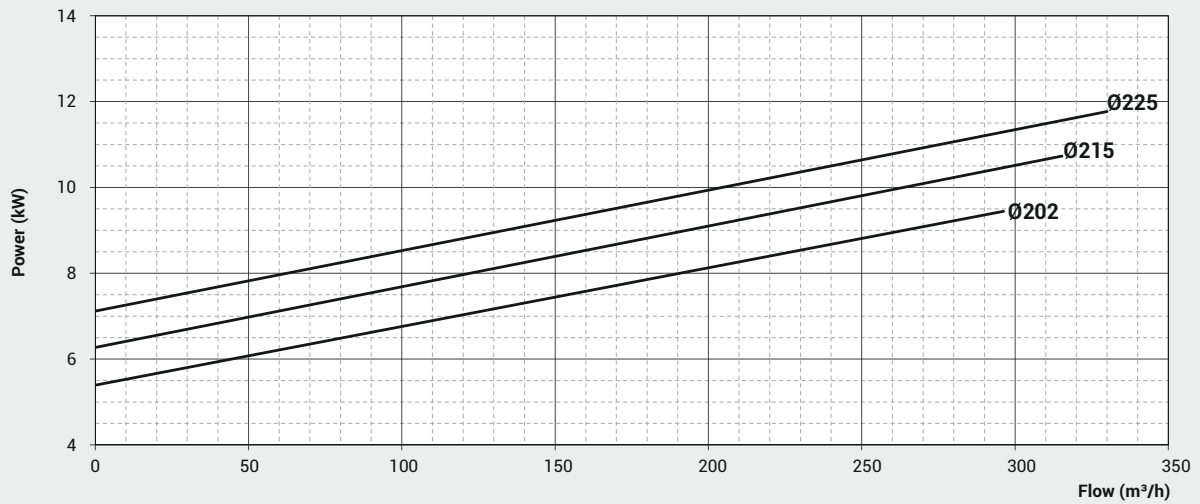
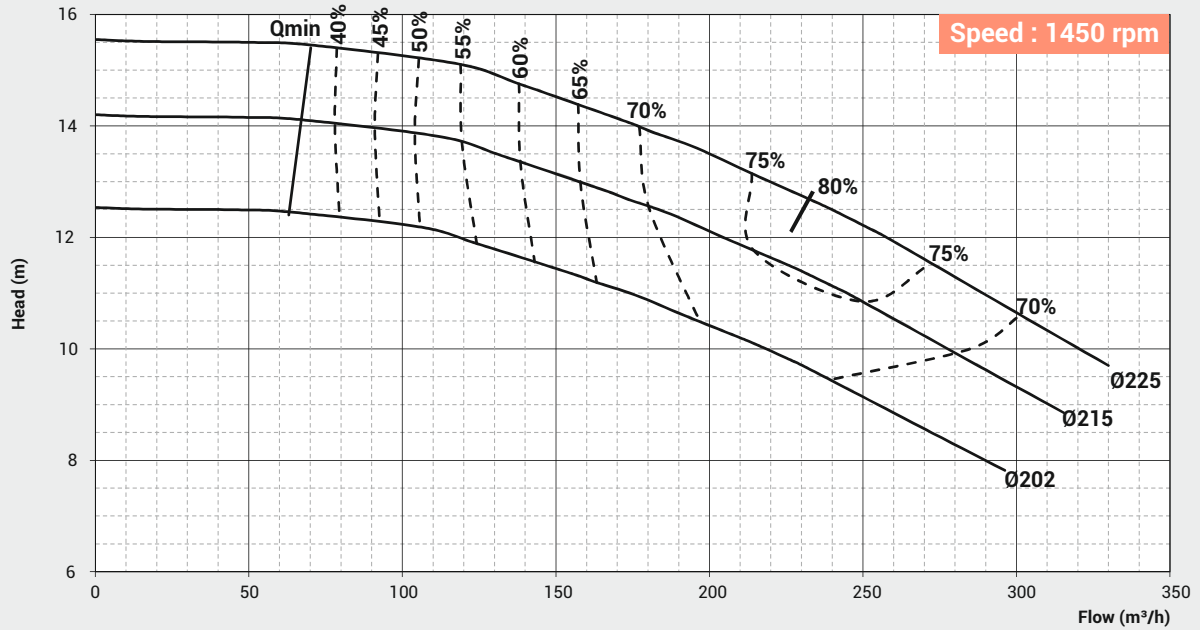

PERFORMANCE CURVE

Pump Model : FIC - 150/200-2

Pump Size in mm : 150 x 150

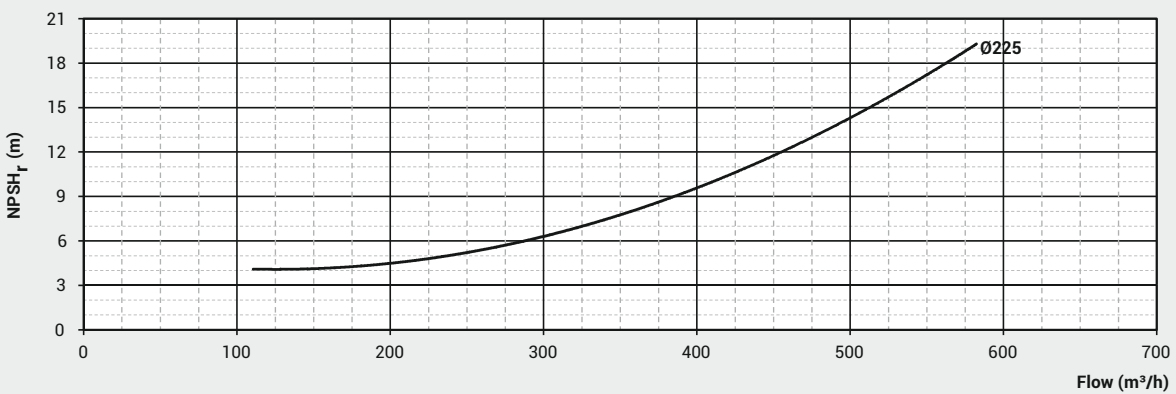
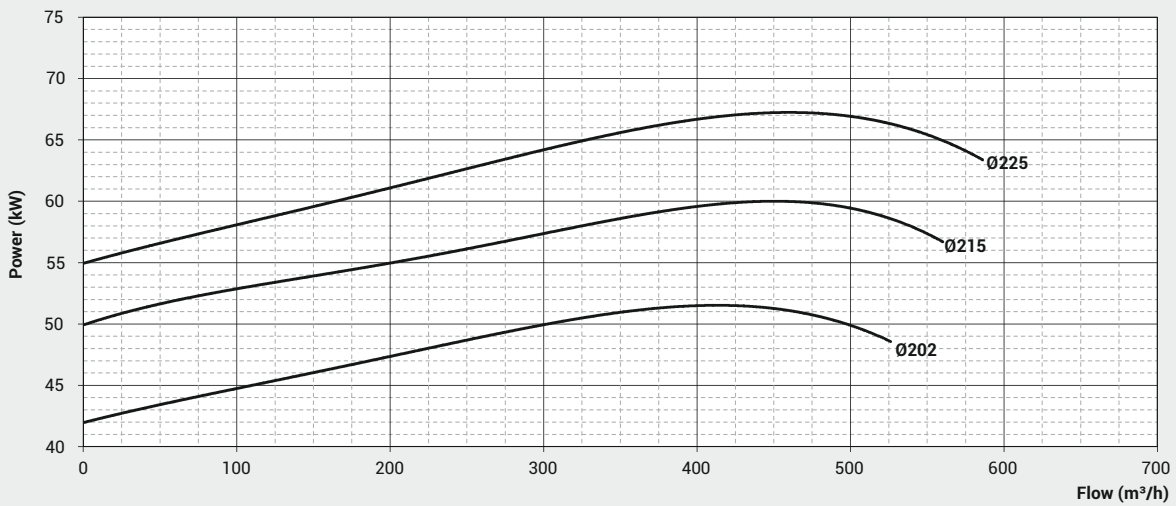
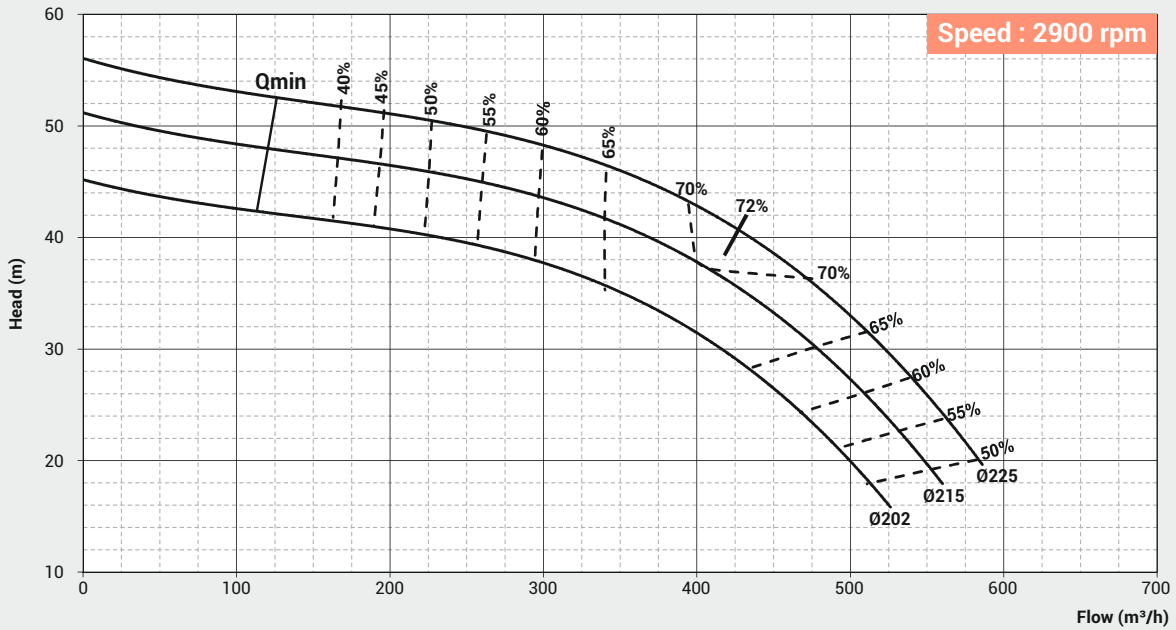

PERFORMANCE CURVE

Pump Model : FIS - 150/250-4 /
FIC - 150/250-4

Pump Size in mm : 150 x 150

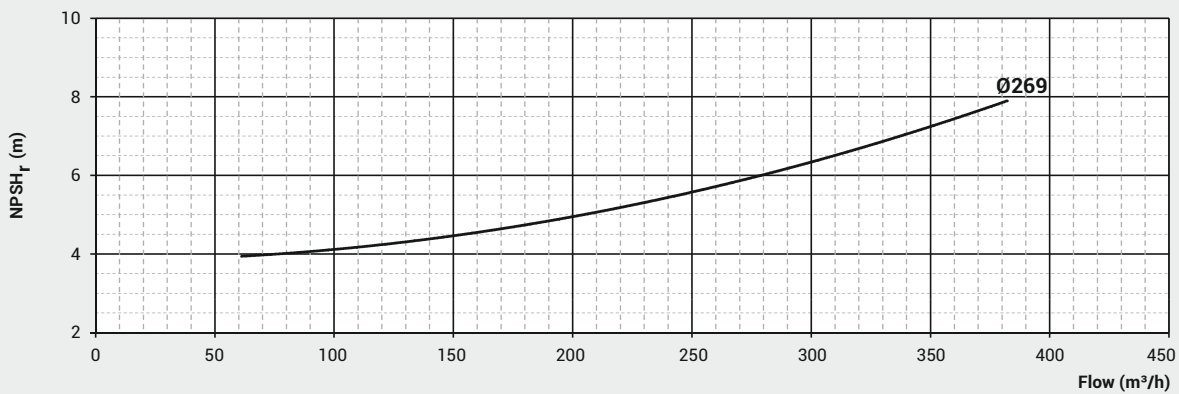
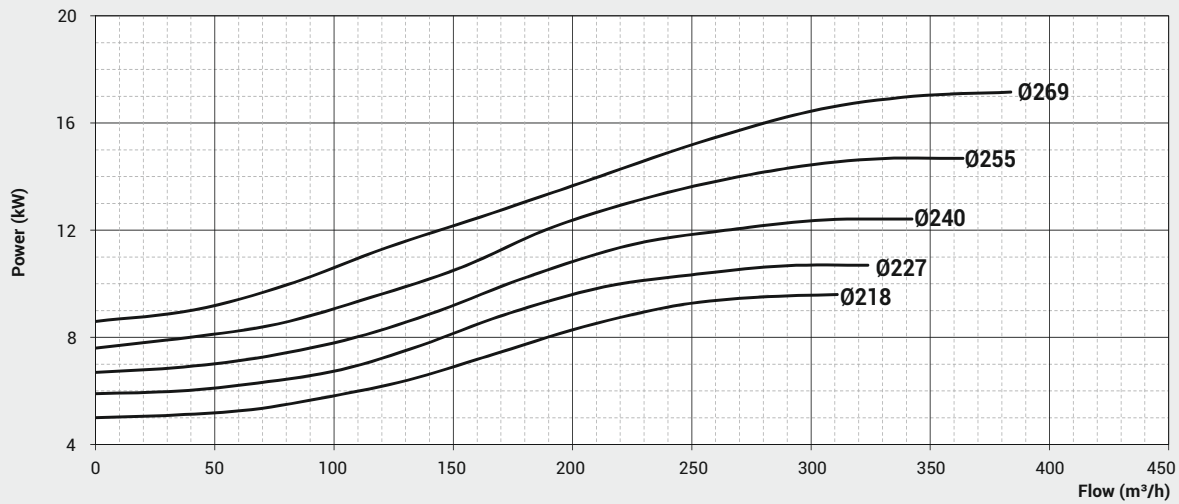
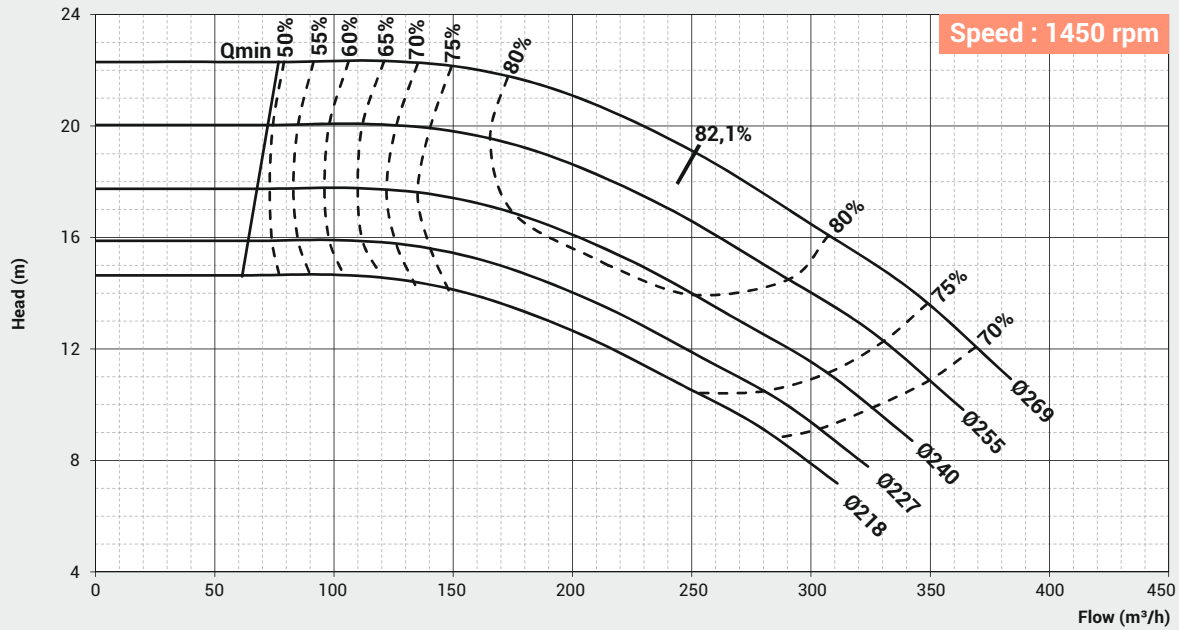

PERFORMANCE CURVE

Pump Model : FIS - 150/380-4 /
FIC - 150/380-4

Pump Size in mm : 150 x 150

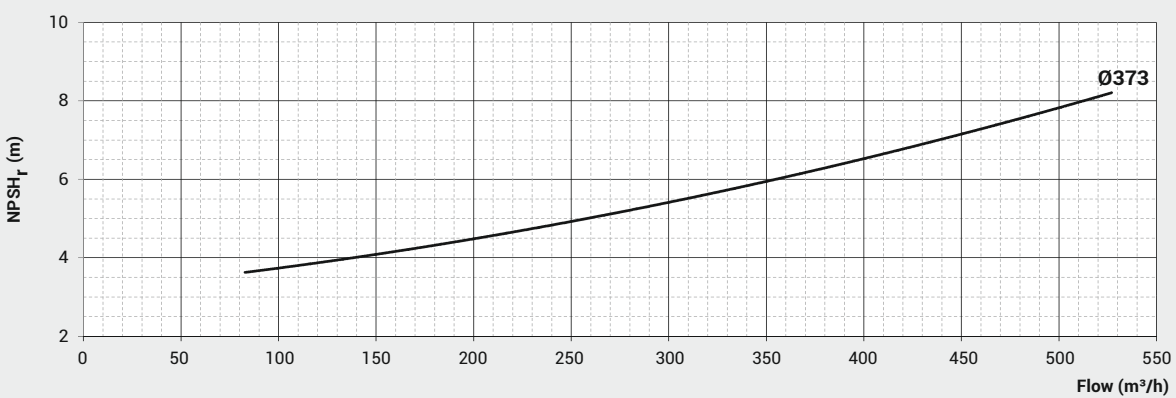
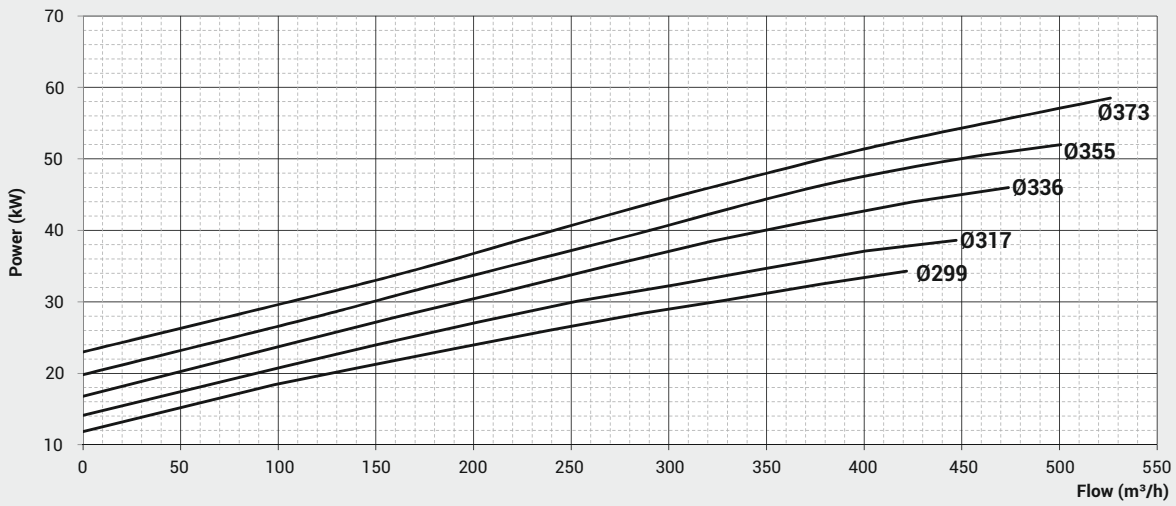
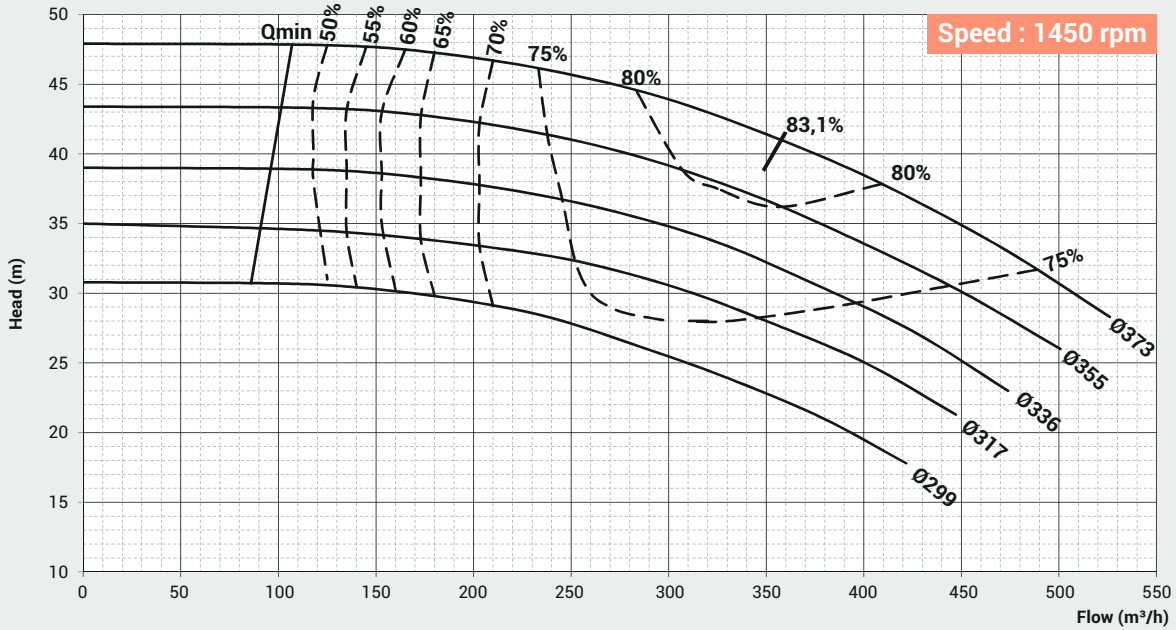

PERFORMANCE CURVE

Pump Model : FIS - 200/250-4 /
FIC - 200/250-4

Pump Size in mm : 200 X 200

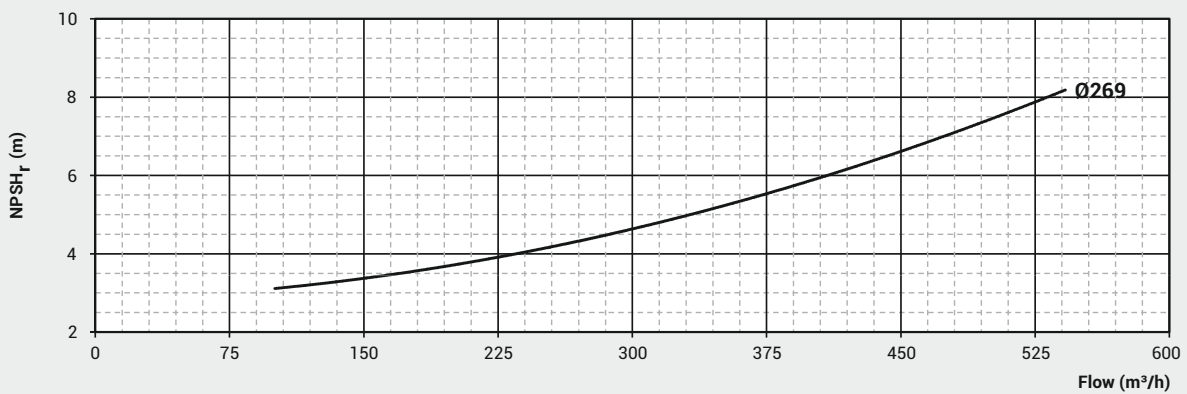
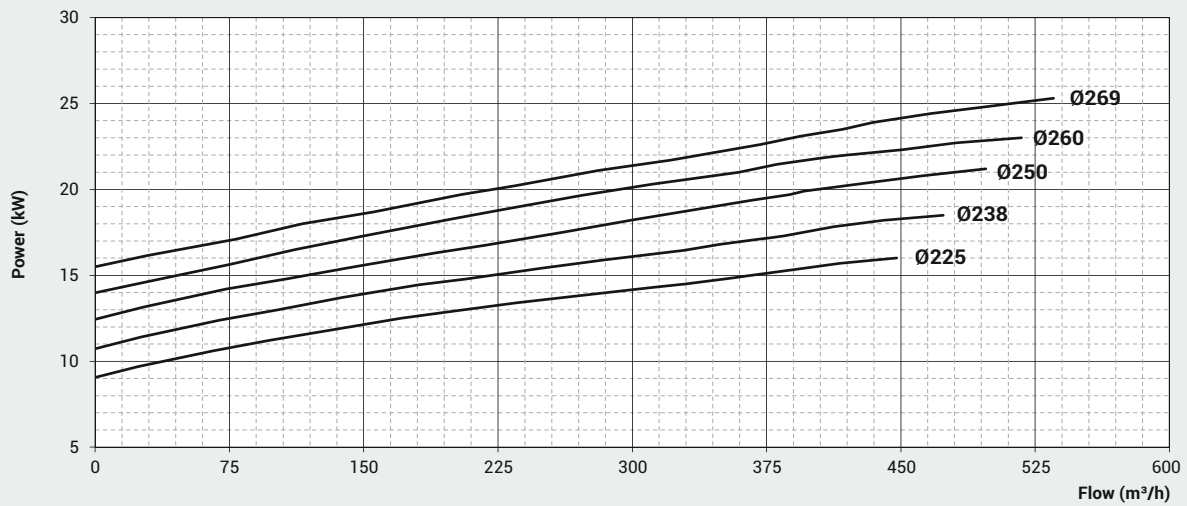
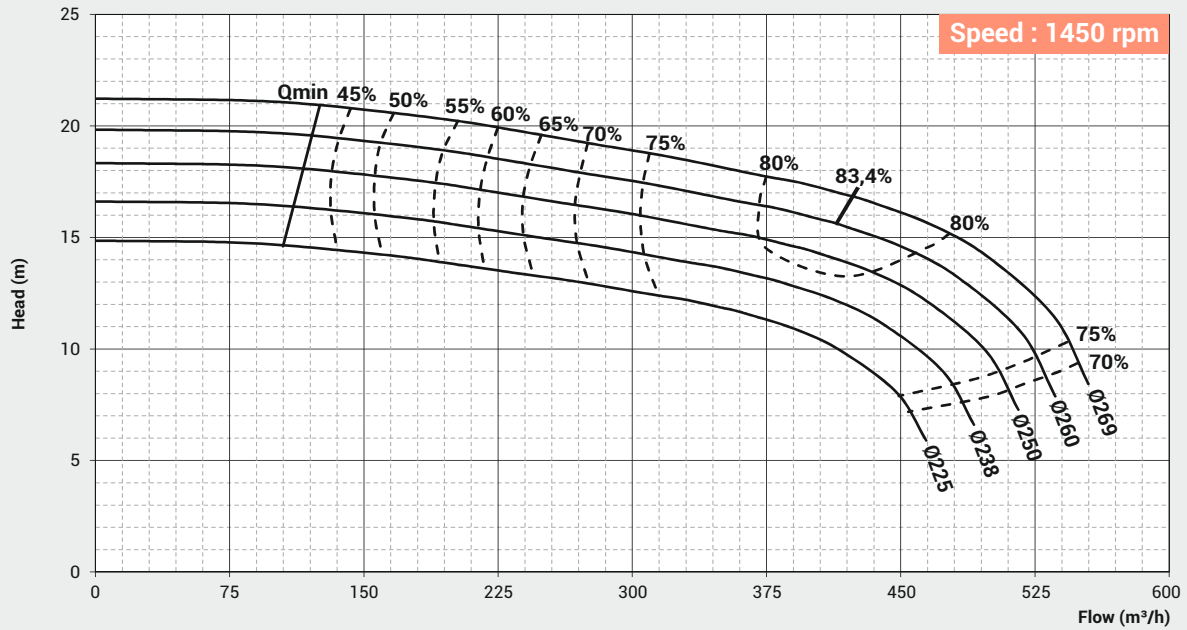

PERFORMANCE CURVE

Pump Model : FIS - 200/380-4 /
FIC - 200/380-4

Pump Size in mm : 200 x 200

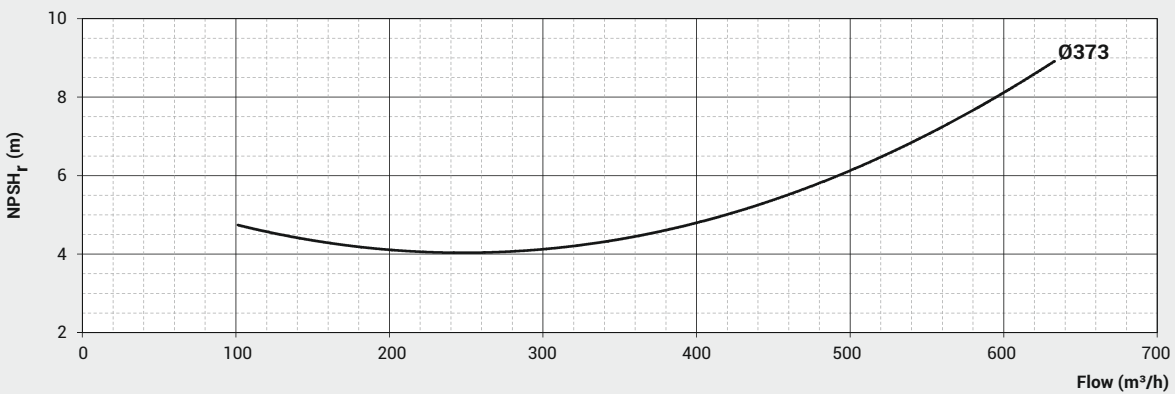
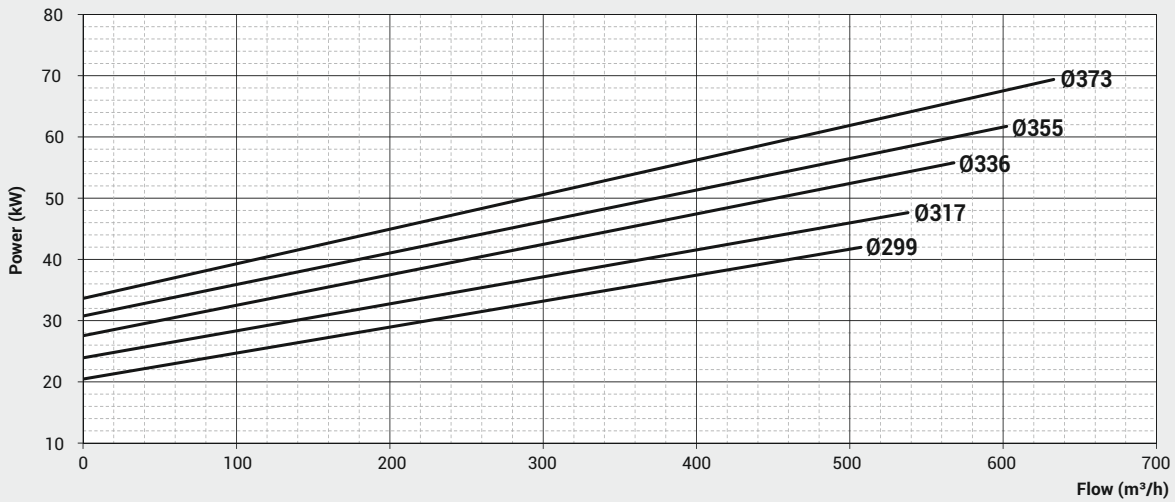
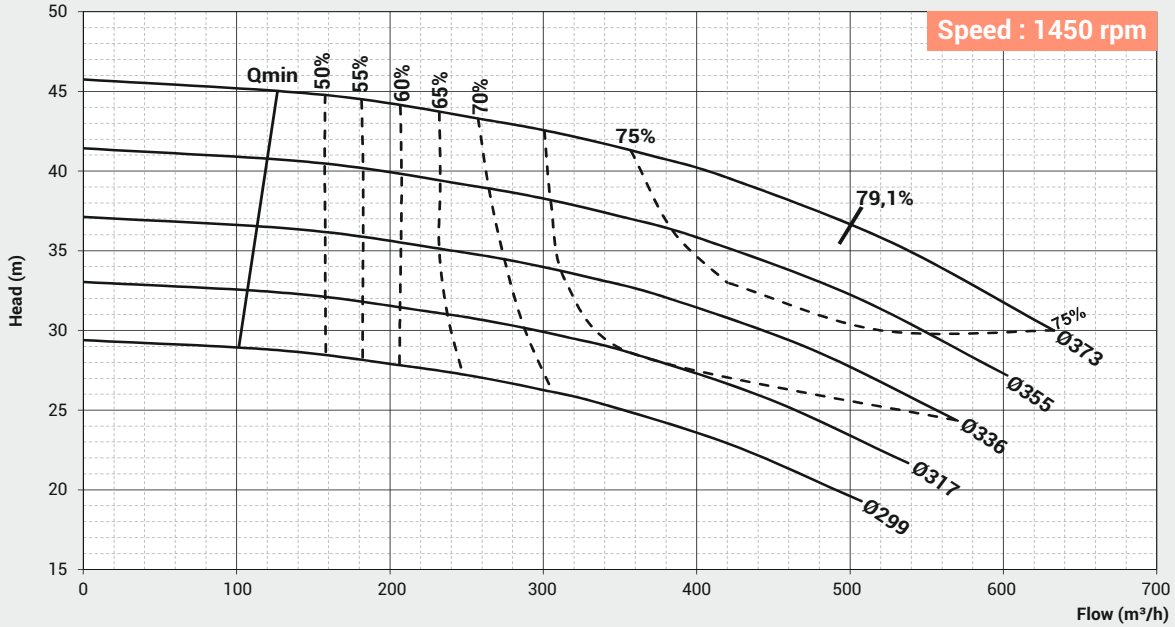



Zirantec

Fabbrica Italiana Pompe Sommergibili S.r.l.

Viale Toscana, 46 - 20089 Rozzano (MI) - Italy
Tel. (+39) 02 8258923 - 02 57510371 Fax 02 57512095
E-mail: info@fips-pumps.it
www.zirantec.com; www.fips-pumps.it