

## CENTRIFUGAL MONO BLOCK PUMPS

FCT SERIES



## SPECIFICATIONS

Power Range	: Upto - 2,2kW
Speed	: 2900 rpm
Degree of Protection	: IP 44 / IP 54
Class of Insulation	: 'B'
Versions	: Single phase - 230V, 50Hz, A.C. Supply (Permanent split capacitor-PSC) Incorporated with Thermal Overload Protector. Three phase - 380-415V, 50Hz A.C. supply
Type of Duty	: S1 (Continuous).
Nominal Delivery Size	: Upto 80mm
Nominal Suction Size	: Upto 80mm
Connection	: Screw / Flange type (BSP)

## MATERIALS OF CONSTRUCTION

Pump Casing	: Cast Iron
Motor Frame	: Aluminium / Cast Iron
Impeller	: Cast Iron / S.S / Plastic / Bronze
Shaft	: S.S 410 / S.S 304 / Carbon Steel
Sealing	: Mechanical Seal (Carbon & Ceramic)

## PUMP OPERATING LIMITS

Maximum Head	: Upto 52,5m
Maximum Suction Lift	: Upto 7m
Maximum Liquid Temperature	: Upto 40°C
Maximum Ambient Temperature	: Upto 50°C

## MODEL IDENTIFICATION CODE

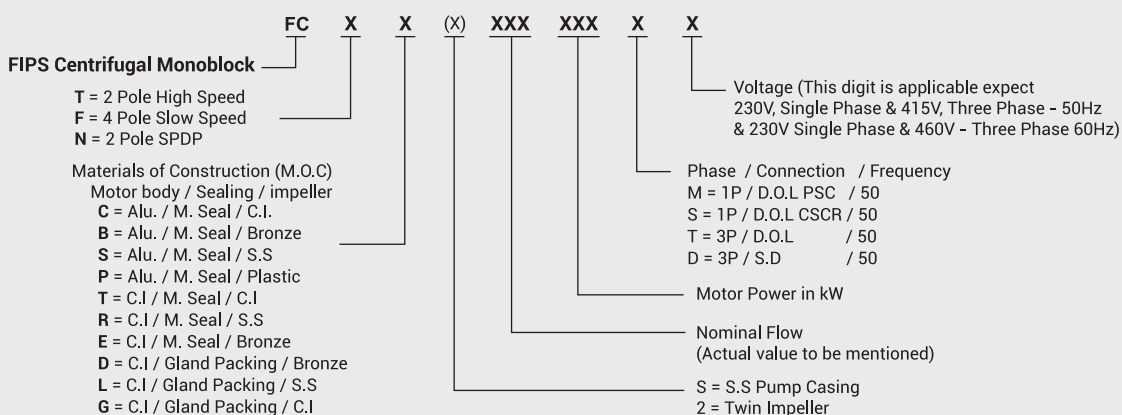

## FEATURES

- High Operating efficiency resulting in lower power consumption.
- Dynamically balanced rotating parts. Ensure noise and vibration free operation.
- Inbuilt thermal overload protector in all single phase pumps.

## APPLICATIONS

Residential, Irrigation, Farms, Utility Water Supply in Industries, General Water Supply, Drip & Sprinkler Irrigation Systems and Water treatment plants.

## PERFORMANCE CHARTS

### FCT SERIES

PUMP MODEL	MOTOR POWER		RATED CURRENT(A)		NOMINAL PUMP SIZE in Inches (Suc x Del)	DISCHARGE IN lps / m <sup>3</sup> /h							
	kW	HP	1Ph 230V	3Ph 380V		0	0,3	0,6	0,8	1,1	1,4	1,7	1,9
						0	1	2	3	4	5	6	7
TOTAL HEAD IN METRES													
FCTS-4/03M	0,37	0,5	4,6	1,6	1" x 1"	22	20,5	18,5	17	16,5	14	12	
FCTS-5/05M	0,55	0,75	5,5	2	1" x 1"	31	30	27	26	25	24	15	
FCTS-6/07M	0,75	1,0	6,4	2,5	1" x 1"	33	31,5	29,5	27,5	26	23	15	
FCTB-6/11M	1,1	1,5	8,85	2,65	1" x 1"	39	38	37	34,5	32	28	22	15 (6,3m <sup>3</sup> /h)
FCTB-8/15M	1,5	2,0	9,38	3,51	1" x 1"	43	42	38,5	37	33	30	25	15 (6,7m <sup>3</sup> /h)

PUMP MODEL	MOTOR POWER		NOMINAL PUMP SIZE in Inches (Suc x Del)	DISCHARGE IN lps / m <sup>3</sup> /h											
	kW	HP		0	0,6	0,8	1,1	1,4	1,7	1,9	2,2	2,5	2,8	2,5	
				0	2	3	4	5	6	7	8	9	10	11	
TOTAL HEAD IN METRES															
FCTB-7/11M	1,1	1,5	1¼" x 1"	34	33	32	30,5	29	28	27	25	24	23	20	

## PERFORMANCE CURVES

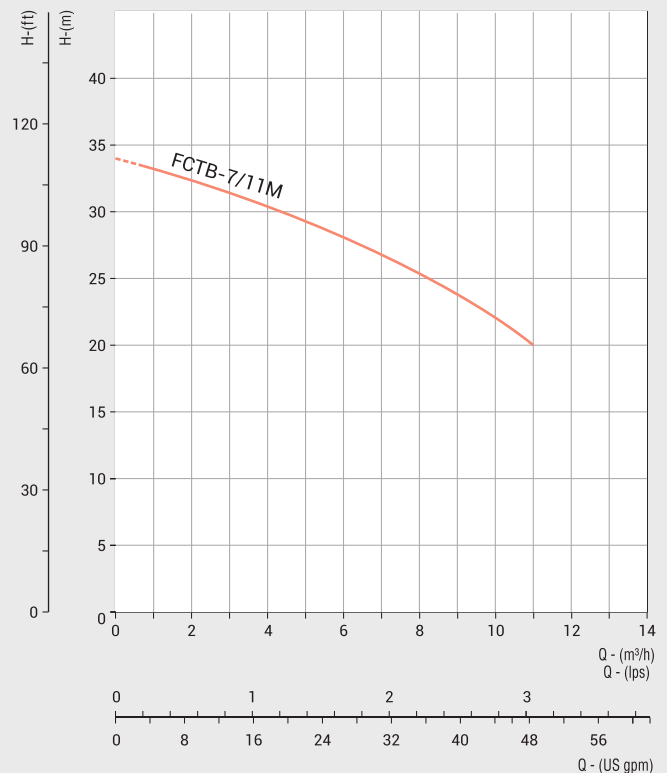
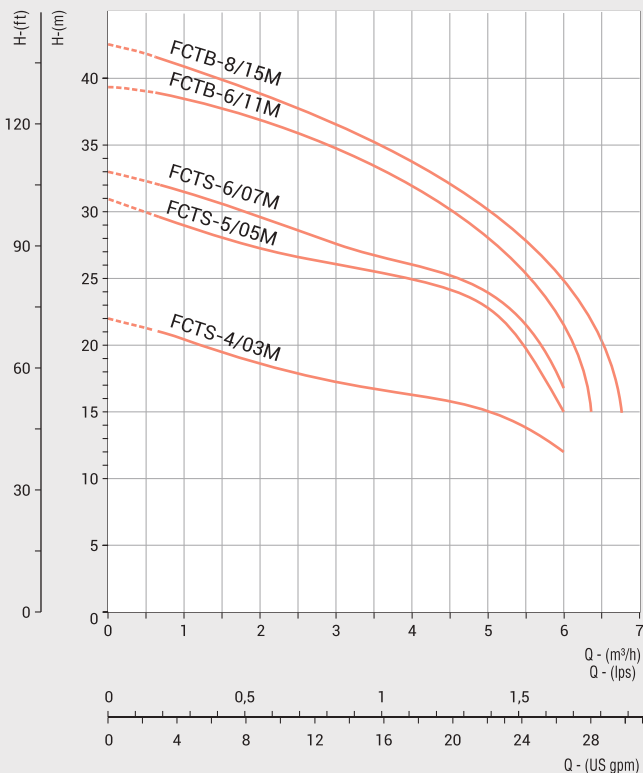

## PERFORMANCE CHARTS

### FCT SERIES

PUMP MODEL	MOTOR POWER		RATED CURRENT(A)		NOMINAL PUMP SIZE in Inches (Suc x Del)	DISCHARGE IN lps / m <sup>3</sup> /h							
	kW	HP	1Ph 230V	3Ph 380V		0	1,4	2,1	2,8	3,5	4,2	5,6	6,7
						0	5	7,5	10	12,5	15	20	24
TOTAL HEAD IN METRES													
FCTB-15/11M	1,1	1,5	7,5	2,8	2" x 2"	20	20	19,5	18,5	18	17,5	14	10
FCTB-18E/15M	1,5	2,0	11	4	2" x 2"	25	24	23	22	21	20	16	11,5

PUMP MODEL	MOTOR POWER		RATED CURRENT(A)		NOMINAL PUMP SIZE in Inches (Suc x Del)	DISCHARGE IN lps / m <sup>3</sup> /h										
	kW	HP	1Ph 230V	3Ph 380V		0	2,8	3,3	3,9	4,4	5	5,6	6,1	6,7	7,2	7,8
						0	10	12	14	16	18	20	22	24	26	28
TOTAL HEAD IN METRES																
FCTC-20/11M*	1,1	1,5	9,5	3	2" x 1½"	22	19,2	18	17,7	17	16	15	13,6	12,5	10,4	-
FCTC-21F/15M*	1,5	2,0	12,5	4	2" x 2"	27	23,8	23	22,5	22	21	20	19	17,5	16	14
FCTC-20/22M*	2,2	3,0	18	5,2	2" x 2"	32	30	29,5	28,5	27,5	26	24	20 (21m <sup>3</sup> /h)			

\* Flange type Connection

## PERFORMANCE CURVES

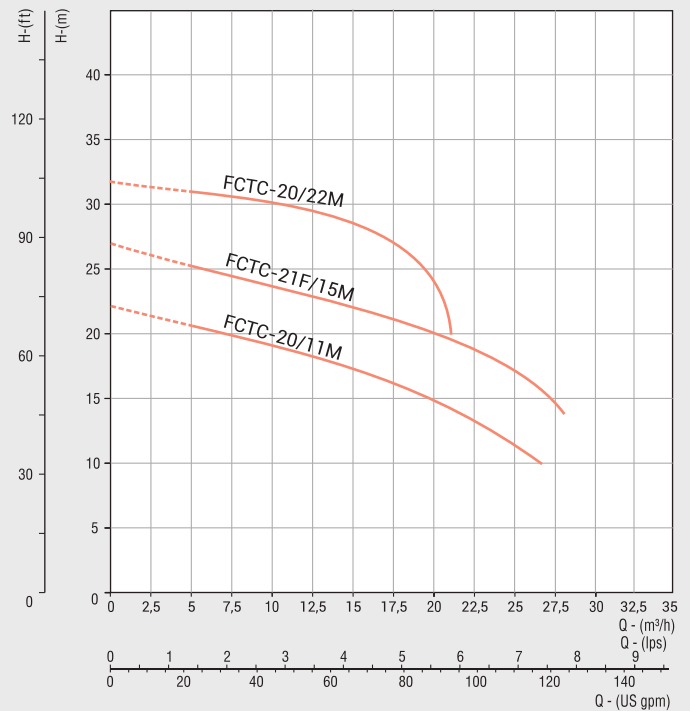
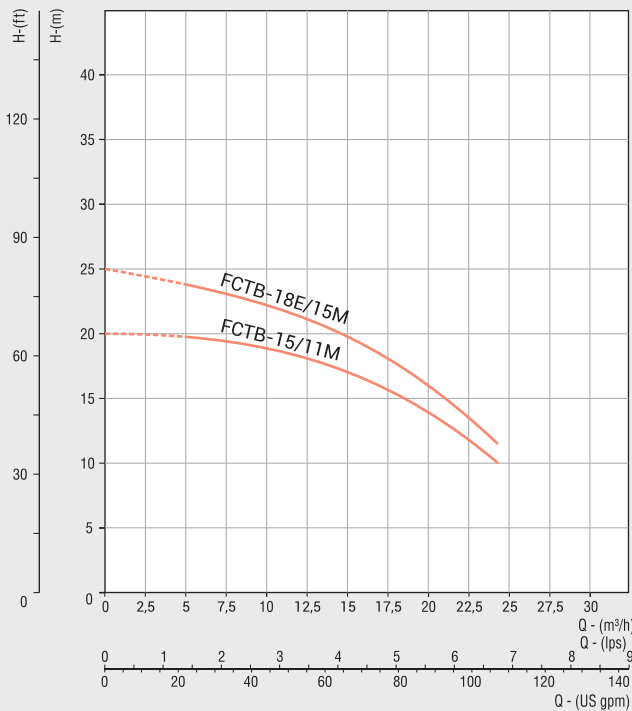

## PERFORMANCE CHART

### FCT SERIES

PUMP MODEL	MOTOR POWER		RATED CURRENT (A)		NOMINAL PUMP SIZE in Inches (Suc x Del)	DISCHARGE IN lps / m <sup>3</sup> /h								
						0	2,8	4,17	5,56	6,94	8,33	9,72	11,11	12,5
	kW	HP	1Ph 230V	3Ph 380V		0	10	15	20	25	30	35	40	45
TOTAL HEAD IN METRES														
FCTC-30/22M*	2,2	3,0	18	5,2	2½" x 2"	22	21	20	18,5	17,5	15	13	12 (36m <sup>3</sup> /h)	
FCTB-35/22M	2,2	3,0	14	5,5	3" x 3"	14,5	14	14	13,5	13	12,5	11,5	10	9 (42m <sup>3</sup> /h)

\* Flange type Connection

## PERFORMANCE CURVES

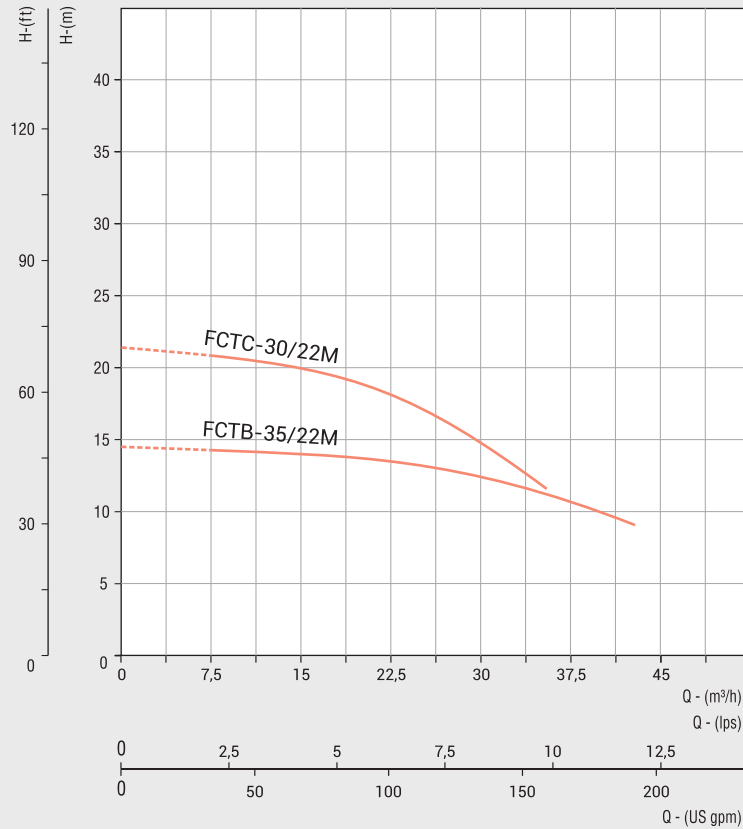

## PERFORMANCE CHART

### FCT SERIES - TWIN IMPELLER

PUMP MODEL	MOTOR POWER		RATED CURRENT(A)		NOMINAL PUMP SIZE in Inches (Suc x Del)	DISCHARGE IN lps / m <sup>3</sup> /h								
	kW	HP	1Ph 230V	3Ph 380V		0	0.6	0.8	1.1	1.4	1.7	1.9	2.2	2.5
						0	2	3	4	5	6	7	8	9
TOTAL HEAD IN METRES														
FCTB2-5/11M	1,1	1,5	8,32	2,65	1¼" x 1"	47,5	43	41	38	35,5	32	27,5	22	
FCTB2-6/15M	1,5	2	10,13	4,2	1¼" x 1"	50,5	47	43	41	38	35	30	25	
FCTB2-7/22M	2,2	3	13,43	5,2	1¼" x 1"	52,5	48,5	46	44	42	38,5	35	31	26

## PERFORMANCE CURVES

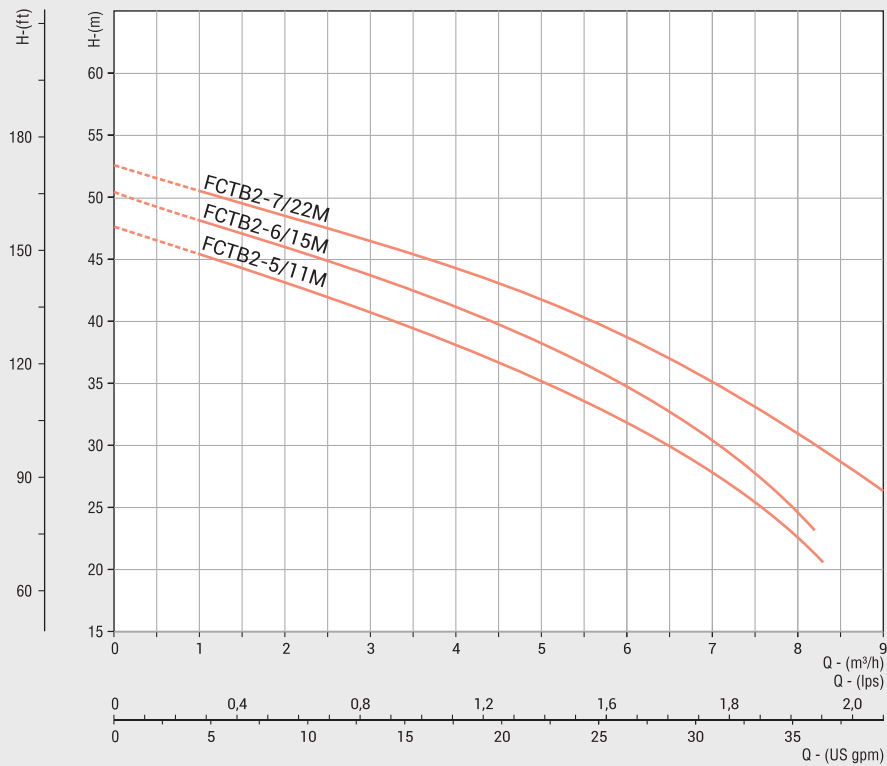

## DIMENSIONAL DATA

### FCT SERIES

PUMP MODEL	MOTOR POWER		A	B	C	D	E	F	G	APPROX. NETT WT in kg
	kW	HP								
FCTS-4/03M	0,37	0,5	46	20	285	113	150	84	207	9,5
FCTS-5/05M	0,55	0,75	48	27	320	140	182	100	240	15
FCTS-6/07M	0,75	1,0	48	27	320	140	182	100	240	15,5
FCTB-6/11M	1,1	1,5	44	46	352	180	220	115	284	21,5
FCTB-7/11M	1,1	1,5	50	25	302	140	200	105	255	19
FCTB-8/15M	1,5	2,0	44	46	363	180	220	115	284	22,5
FCTB-15/11M	1,1	1,5	60	20	375	160	207	112	159	22
FCTB-18E/15M	1,5	2,0	57	44	385	135	182	107	218	23
FCTC-20/11M*	1,1	1,5	65	-	405	110	200	108	265	26
FCTC-21F/15M*	1,5	2,0	70	-	430	104	200	108	270	28,6
FCTC-20/22M*	2,2	3,0	67	-	464	176	232	121	299	38,4
FCTC-30/22M*	2,2	3,0	68	65	435	190	240	120	312	30
FCTB-35/22M	2,2	3,0	68	-	434	190	240	120	315	40
FCTB2-5/11M	1,1	1,5	81	20	387	170	210	117	264	21,5
FCTB2-6/15M	1,5	2,0	81	20	387	170	210	117	264	22,5
FCTB2-7/22M	2,2	3,0	90	38	450	190	240	135	300	30,5

\* Flange type Connection

\* All Dimensions are in mm.

## DIMENSIONAL DRAWINGS

